



Bombas Fundición de Hierro - Rodete en Bronce

Cast Iron Pumps - Impeller in Bronze

50Hz

8SB

BOMBA 8SB

Caudales hasta 205 m³/h a 2850rpm
 Altura manométrica hasta 420m a 2850rpm
 Impulsiones de 5"
 Ensayos de acuerdo con norma ISO 9906

8SB PUMP

- Capacity up to 205m³/h for 2850rpm
- Head up to 420m for 2850rpm
- Outlet 5"
- Test according ISO 9906

MOTORES SUMERGIBLES EMC

Motores Sumergibles Rebobinables EMC de 6", 7", 8" o 10" hasta 150 CV
 Tensión Trifásica 230-400/690V - 50Hz - Tolerancia ±10%
 Protección IP 68 - Clase de Aislamiento Tipo F
 Temperatura Máx. del agua 30°C (Opcional temp. Máx. 70°C)
 Instalación en Vertical y en Horizontal
 Arranque máximos por hora 15
 Velocidad mínima de refrigeración: 0.2 m/s
 Acoplamiento NEMA

EMC SUBMERSIBLE MOTORS

- 6", 7", 8" and 10" Rewindable Submersible Motors EMC up to 150 CV
- Triphase Voltage 230-400/690V - 50Hz - ±10% Tolerance
- IP 68 - Isolation F type
- Water Maximum Temperature 30°C (Optional 70°C)
- The motor can operate vertically and horizontally
- Maximum start/hour 15
- Minimum cooling water speed : 0.2 m/s
- NEMA coupling

CARACTERÍSTICAS

Electrobomba sumergible centrífuga multicelular fabricadas en fundición de hierro
 Cuerpos de aspiración y de impulsión fabricados en fundición GG25
 Impulsores en Bronce para mejor resistencia mecánica
 Tornillería y rejilla en acero inoxidable AISI 304
 Válvula de retención y protección de cable en AISI 304
 Eje y acoplamiento motor en AISI 304
 Acoplamiento norma NEMA 1-18-388

CHARACTERISTICS

- Submersible Centrifugal pump in cast iron
- Suction and discharge case in cast iron GG25
- Impellers in Bronze for better resistance
- Screw and filter in AISI 304
- Check-valve and cable guard in AISI 304
- Shaft and motor coupling in AISI 304
- NEMA 1-18-388 coupling

APLICACIONES

Bombas para aplicaciones en bombeos de aguas de pozos, depósitos, ríos, lagos.
 Abastecimiento de agua, riego, sistemas contra incendios, aplicaciones industriales, sistemas de presurización.

APPLICATIONS

- Pumps for pumping in well water, lakes, river.
- Domestic and civil water supply, irrigation, fire-fighting, industrial applications and pressure system.

50Hz

Bombas Fundición de Hierro - Rodete en Bronce

Cast Iron Pumps - Impeller in Bronze

8SB

DESPIECE • CUTTING

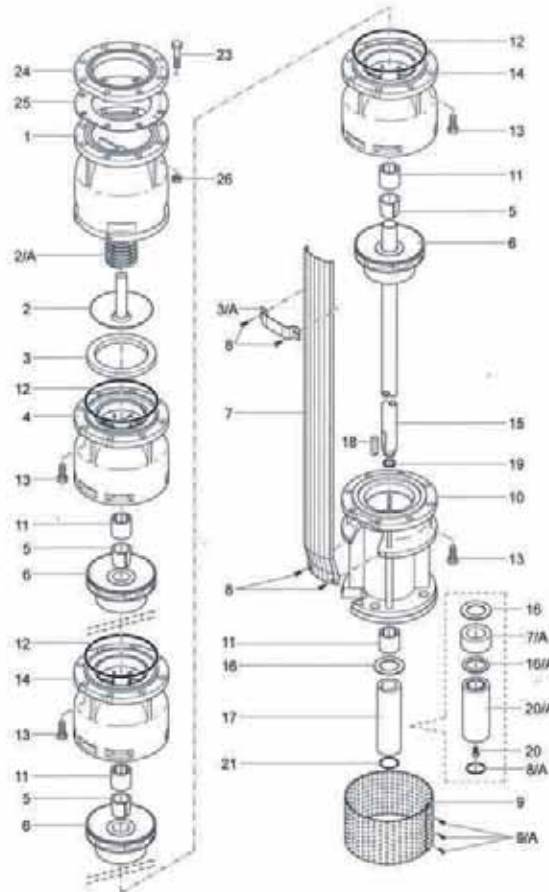

Nº	DESCRIPCIÓN DESCRIPTION	MATERIAL MATERIAL
1	Cuerpo Impulsión Discharge Case	Fundición de Hierro Cast Iron
2A	Muelle Válvula Valve Spring	Acero Inoxidable AISI 304 Stainless Steel AISI 304
2	Hongo Válvula Check Valve	Acero Inoxidable AISI 304 Stainless Steel AISI 304
3A	Abrazadera Protec. Cable Cable guard clamp	Acero Inoxidable AISI 304 Stainless Steel AISI 304
3	Asiento Válvula Goma Valve Gasket Ring	Goma Rubber
4	Difusor Descarga Upper Diffuser	Fundición de Hierro Cast Iron
5	Cono fija rodete Conic lock sleeve	Acero Inoxidable AISI 400 Stainless Steel AISI 400
6	Rodete Impeller	Bronce Bronze
7	Protección Cable Cable Guard	Acero Inoxidable AISI 304 Stainless Steel AISI 304
7A	Distanciador Manguito Coupling Space Sleeve	Acero Inoxidable AISI 400 Stainless Steel AISI 400
8	Tornillo Protección Cable Screw cable Guard	Acero Inoxidable AISI 304 Stainless Steel AISI 304
8A	Junta Tórica Manguito 6" O'ring for coupling 6"	Goma Rubber
9	Filtro de aspiración Suction Filter	Acero Inoxidable AISI 304 Stainless Steel AISI 304
9A	Tornillo filtro Screw for filter	Acero Inoxidable AISI 304 Stainless Steel AISI 304
10	Soporte de aspiración Suction Casing	Fundición de Hierro Cast Iron
11	Cojinete bomba Bearing bush	Acero + Goma Steel + Rubber

Nº	DESCRIPCIÓN DESCRIPTION	MATERIAL MATERIAL
12	Junta Torica Gasket	Goma Rubber
13	Tornillo Screw	Acero Inoxidable AISI 304 Stainless Steel AISI 304
14	Difusor Diffuser	Fundición de Hierro Cast Iron
15	Eje Shaft	Acero Inoxidable AISI 420 Stainless Steel AISI 420
16	Disco contraempuje Counterthrust plate	Teflón Grafitado Graphited Teflon
16A	Disco contraempuje II Counterthrust plate II	Teflón Grafitado Graphited Teflon
17	Manguito 8" Coupling 8"	Acero Inoxidable AISI 400 Stainless Steel AISI 400
18	Chaveta Key	Acero Inoxidable AISI 304 Stainless Steel AISI 304
19	Anillo por manguito Coupling circlip	Acero Inoxidable AISI 304 Stainless Steel AISI 304
20	Tornillo por manguito Screw for coupling	Acero Inoxidable AISI 304 Stainless Steel AISI 304
20A	Manguito 6" Coupling 6"	Acero Inoxidable AISI 400 Stainless Steel AISI 400
21	Junta Tórica Manguito 8" O'ring for coupling 8"	Goma Rubber
23	Tornillo para Brida Screw for flange	Acero Inoxidable AISI 304 Stainless Steel AISI 304
24	Brida Flange	Fundición de Hierro Cast Iron
25	Junta Brida Gasket Flange	Goma Rubber
26	Tuerca Nut	Acero Inoxidable AISI 304 Stainless Steel AISI 304

Debido a continuas mejoras en los diseños, EMC BOMBAS se reserva el derecho de realizar modificaciones sin previo aviso.
Due to continuous improvement in design EMC BOMBAS reserves the right to amend specifications or date without prior notice.



Bombas Fundición de Hierro - Rodete en Bronce

Cast Iron Pumps - Impeller in Bronze

50Hz

8SB 72

Características 50Hz • Performance 50Hz

Bomba Pump	Motor		Q	Caudal • Capacity											
			l/s	0	9	10,0	11,0	12,0	13,0	14,0	15,0	16,0	17,0	18,0	20,0
	kW	HP	m ³ /h	0	32,4	36,0	39,6	43,2	46,8	50,4	54,0	57,6	61,2	64,8	72,0
			l/min	0	540	600	660	720	780	840	900	960	1020	1080	1200
8SB-72/1	4	5,5	Altura • Head H (m)	24	22	21	20	19	18	17	16	15	13	12	10
8SB-72/2	7,5	10		51	44	43	42	40	38	36	34	32	30	28	23
8SB-72/3	11	15		75	65	63	61	59	56	53	51	47	43	39	32
8SB-72/4R	13	17,5		94	81	79	76	73	69	66	63	59	54	49	40
8SB-72/5R	15	20		109	95	93	90	85	81	78	73	67	60	55	43
8SB-72/6R	18,5	25		134	118	114	111	106	101	96	91	84	77	70	56
8SB-72/7R	22	30		160	139	134	130	125	119	113	107	99	91	82	66
8SB-72/8R	26	35		181	162	158	152	145	138	132	126	117	107	98	79
8SB-72/9R	30	40		207	182	177	171	164	156	148	142	132	121	110	90
8SB-72/10	37	50		252	219	214	207	199	187	178	170	158	152	139	113
8SB-72/12	45	60		303	263	258	249	239	224	213	203	190	182	167	136
8SB-72/14	52	70		354	306	300	290	279	262	249	236	221	212	196	159
8SB-72/15	55	75		378	329	321	311	298	280	266	254	238	228	209	170
8SB-72/16	60	80		403	351	343	331	318	299	284	271	253	243	223	181
8SB-72/18	66	90		455	395	386	373	358	336	320	305	285	273	251	204
8SB-72/20	75	100		505	439	428	414	398	374	355	339	317	304	279	227

Información Técnica Motor Sumergible • Technical Information Sumersible

Bomba Pump	Potencia Power		Tipo Motor Motor Type	U _N	Información Motor • Motor information											
					n	I _N	I _A	η			cos φ			Ax.	P	L
	min ⁻¹	(A)	50		75	100	50	75	100	kN	(kg)	(mm)				
8SB-72/1	4	5,5	EMC/6 5,5	400 V	2855	9,9	38	0,68	0,72	0,72	0,59	0,67	0,81	20	44,0	649
8SB-72/2	7,5	10	EMC/6 10		2860	16,7	65	0,79	0,80	0,80	0,59	0,67	0,81		53,0	758
8SB-72/3	11	15	EMC/6 15		2855	23,6	91	0,82	0,83	0,83	0,63	0,71	0,81		61,0	851
8SB-72/4R	13	17,5	EMC/6 17,5		2875	27,9	107	0,81	0,82	0,82	0,61	0,69	0,82		66,0	911
8SB-72/5R	15	20	EMC/6 20		2875	32,2	120	0,80	0,81	0,81	0,61	0,69	0,83	72,0	973	
8SB-72/6R	18,5	25	EMC/6 25		2868	40,2	155	0,81	0,82	0,82	0,57	0,66	0,81	80,0	1006	
8SB-72/7R	22	30	EMC/6 30		2875	46,7	180	0,82	0,83	0,83	0,59	0,67	0,82	86,0	1106	
8SB-72/8R	26	35	EMC/6 35		2885	54,9	212	0,83	0,84	0,84	0,61	0,69	0,83	27	90,0	1217
8SB-72/9R	30	40	EMC/8 40		2865	59	229	0,83	0,84	0,84	0,68	0,76	0,87	45	127,0	1056
8SB-72/10	37	50	EMC/8 50		2875	71	276	0,85	0,86	0,86	0,68	0,76	0,87		133,0	1116
8SB-72/12	45	60	EMC/8 60		2864	87	336	0,85	0,86	0,86	0,68	0,76	0,87		140,0	1201
8SB-72/14	52	70	EMC/8 70		2865	99	383	0,85	0,86	0,86	0,71	0,78	0,88		146,0	1286
8SB-72/15	55	75	EMC/8 75		2864	108	415	0,83	0,84	0,84	0,71	0,78	0,88		152,0	1282
8SB-72/16	60	80	EMC/8 80		2865	116	447	0,85	0,86	0,86	0,68	0,76	0,87		160,0	1341
8SB-72/18	66	90	EMC/8 90		2865	130	500	0,85	0,86	0,86	0,68	0,76	0,87		169,0	1366
8SB-72/20	75	100	EMC/8 100		2865	145	560	0,84	0,85	0,85	0,71	0,78	0,88		190,0	1391

Más información en fichas técnicas motores sumergibles EMC • More information in technicals specifications of sumersible motors EMC

Cuerpo • Body

Rodete • Impeller

Eje Bomba y Acople • Pump shaft and Coupling

Rejilla y Válvula • Strainer and Valve cap

Diám. Impulsión • Outlet con. diam.

Max. Contenido Arena • Max. Sand Content

Fundición de Hierro GG-25 • Cast Iron GG-25

Bronce • Bronze

Acero Inoxidable AISI 420 • Stainless Steel AISI 420

Acero Inoxidable AISI 304 • Stainless Steel AISI 304

DN120 • DN120

50 gr/m³ • 50 gr/m³

50Hz

Bombas Fundición de Hierro - Rodete en Bronce

Cast Iron Pumps - Impeller in Bronze

8SB 72

Características 50Hz • Performance 50Hz

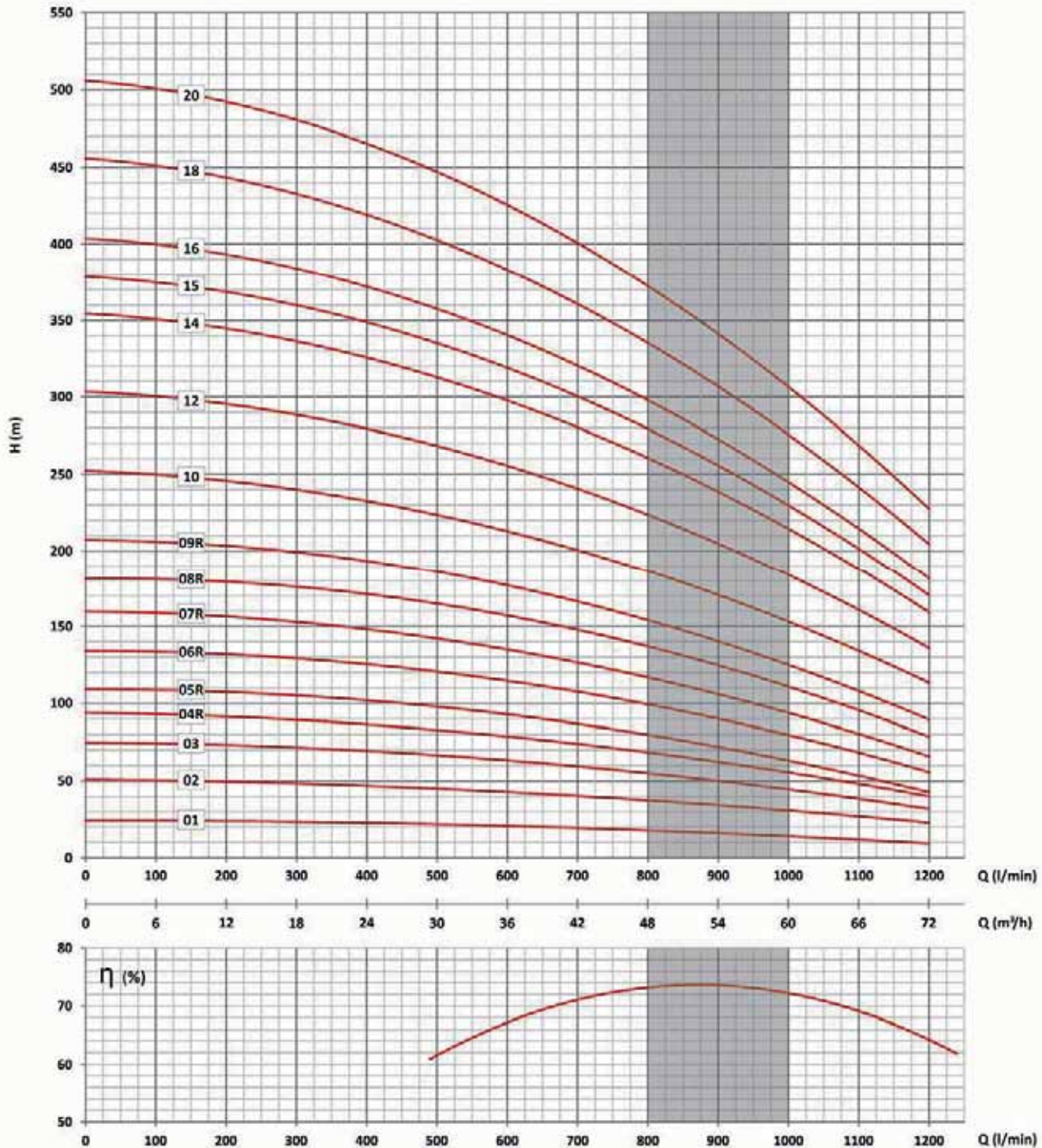

Dimensiones y pesos en páginas posteriores • Dimensions and weights in subsequent pages

Las condiciones de trabajo han sido tomadas en las siguientes condiciones: agua 15°C, presión atmosférica de 1 bar y densidad específica 1gr/cm³ según ISO 9906 Annex A.
The hydraulic working characteristics have been taken with water at 15°C, at the atmospheric pressure of 1 bar and specific gravity is 1gr/cm³, ISO 9906 Annex A.

8SB 72

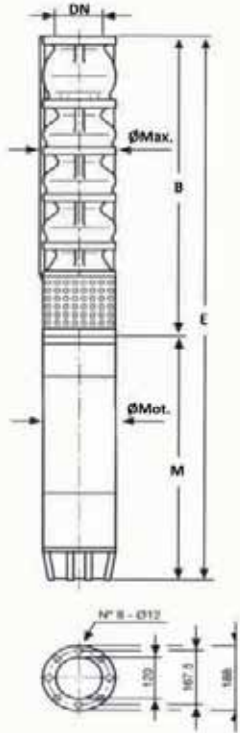
Dimensiones y Pesos • Dimensions and Weights

Dimensiones y peso de la bomba • Pump weight and dimensions							
Tipo Type	E	B	M	ØMax	ØMot.	DN	Peso Bomba Pump Weight
8SB-72/1	1256	607	649	200	144	120	40
8SB-72/2	1501	743	758				52
8SB-72/3	1730	879	851				64
8SB-72/4R	1926	1015	911				76
8SB-72/5R	2124	1151	973				88
8SB-72/6R	2293	1287	1006				100
8SB-72/7R	2529	1423	1106				112
8SB-72/8R	2776	1559	1217				124
8SB-72/9R	2751	1695	1056				136
8SB-72/10	2947	1831	1116				148
8SB-72/12	3304	2103	1201	172			
8SB-72/14	3661	2375	1286	196			
8SB-72/15	3793	2511	1282	208			
8SB-72/16	3988	2647	1341	220			
8SB-72/18	4285	2919	1366	244			
8SB-72/20	4582	3191	1391	268			

8SB 97

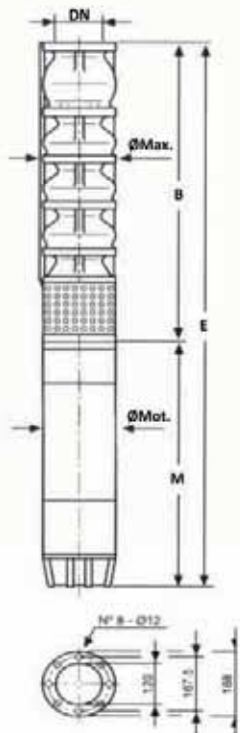
Dimensiones y Pesos • Dimensions and Weights

Dimensiones y peso de la bomba • Pump weight and dimensions							
Tipo Type	E	B	M	ØMax	ØMot.	DN	Peso Bomba Pump Weight
8SB-97/2R	1501	743	758	200	144	120	52
8SB-97/2	1543	743	800				52
8SB-97/3R	1852	879	973				64
8SB-97/3	1885	879	1006				64
8SB-97/4R	2121	1015	1106				76
8SB-97/5R	2368	1151	1217				88
8SB-97/5	2257	1151	1106				88
8SB-97/6R	2504	1287	1217				100
8SB-97/7R	2479	1423	1056				112
8SB-97/8R	2675	1559	1116				124
8SB-97/10R	3032	1831	1201	148			
8SB-97/11	3253	1967	1286	160			
8SB-97/12	3385	2103	1282	172			
8SB-97/13R	3580	2239	1341	184			
8SB-97/15R	3877	2511	1366	208			
8SB-97/16	4038	2647	1391	220			
8SB-97/18	4455	2919	1536	244			
8SB-97/20	4727	3191	1536	268			

8SB 97

Características 50Hz • Performance 50Hz

Bomba Pump	Motor		Q	Caudal • Capacity											
			l/s	0	13	14,0	15,0	17,0	19,0	20,0	22,0	23,0	25,0	26,0	27,0
	kW	HP	m ³ /h	0	46,8	50,4	54,0	61,2	68,4	72,0	79,2	82,8	90,0	93,6	97,2
			l/min	0	780	840	900	1020	1140	1200	1320	1380	1500	1560	1620
8SB-97/2R	7,5	10	Altura • Head H (m)	42	36	35	33	31	29	27	23	22	18	17	15
8SB-97/2	9,2	12,5		50	41	40	39	36	34	32	28	27	23	21	19
8SB-97/3R	11	15		61	52	51	49	46	42	40	35	33	28	26	23
8SB-97/3	13	17,5		71	59	58	56	53	48	46	41	38	33	30	26
8SB-97/4R	15	20		86	70	68	66	62	57	56	49	46	41	38	34
8SB-97/5R	18,5	25		107	87	85	82	77	71	68	61	57	50	47	42
8SB-97/5	22	30		120	100	98	95	89	82	78	69	64	55	51	45
8SB-97/6R	26	35		148	118	116	112	105	96	92	83	78	67	63	57
8SB-97/7R	30	40		166	136	133	129	120	110	105	94	89	77	71	64
8SB-97/8R	37	50		207	165	161	156	146	134	128	115	107	94	88	79
8SB-97/10R	45	60		250	201	196	190	177	164	156	139	129	113	104	94
8SB-97/11	52	70		288	230	225	218	205	188	179	161	152	134	125	113
8SB-97/12	55	75		306	248	243	236	221	203	193	173	164	144	134	121
8SB-97/13R	60	80		335	269	263	256	239	219	208	188	176	153	142	128
8SB-97/15R	66	90		378	305	297	289	269	247	236	210	198	175	163	147
8SB-97/16	75	100		413	338	330	321	300	274	261	234	220	193	179	162
8SB-97/18	92	125		465	380	371	361	338	308	294	263	248	217	201	182
8SB-97/20	92	125		516	423	413	401	375	343	326	292	275	241	224	203

Información Técnica Motor Sumergible • Technical Information Sumersible

Bomba Pump	Potencia Power		Tipo Motor Motor Type	U _N	Información Motor • Motor information										Ax. kN	P (kg)	L (mm)
					n	I _N	I _A	η			cos φ						
	min ⁻¹	(A)			50	75	100	50	75	100							
8SB-97/2R	7,5	10	EMC/6 10	400 V	2860	16,7	65	0,79	0,80	0,80	0,59	0,67	0,81	20	53,0	758	
8SB-97/2	9,2	12,5	EMC/6 12,5		2865	20,5	79	0,80	0,81	0,81	0,59	0,67	0,81		57,0	800	
8SB-97/3R	11	15	EMC/6 15		2855	23,6	91	0,82	0,83	0,83	0,63	0,71	0,81		61,0	851	
8SB-97/3	13	17,5	EMC/6 17,5		2875	27,9	107	0,81	0,82	0,82	0,61	0,69	0,82		66,0	911	
8SB-97/4R	15	20	EMC/6 20		2875	32,2	120	0,80	0,81	0,81	0,61	0,69	0,83	72,0	973		
8SB-97/5R	18,5	25	EMC/6 25		2868	40,2	155	0,81	0,82	0,82	0,57	0,66	0,81	80,0	1006		
8SB-97/5	22	30	EMC/6 30		2875	46,7	180	0,82	0,83	0,83	0,59	0,67	0,82	86,0	1106		
8SB-97/6R	26	35	EMC/6 35		2885	54,9	212	0,83	0,84	0,84	0,61	0,69	0,83	90,0	1217		
8SB-97/7R	30	40	EMC/8 40		2865	59,3	229	0,83	0,84	0,84	0,68	0,76	0,87	127,0	1056		
8SB-97/8R	37	50	EMC/8 50		2875	71,4	276	0,85	0,86	0,86	0,68	0,76	0,87	133,0	1116		
8SB-97/10R	45	60	EMC/8 60		2864	87	336	0,85	0,86	0,86	0,68	0,76	0,87	140,0	1201		
8SB-97/11	52	70	EMC/8 70		2865	99	383	0,85	0,86	0,86	0,71	0,78	0,88	146,0	1286		
8SB-97/12	55	75	EMC/8 75		2864	108	415	0,83	0,84	0,84	0,71	0,78	0,88	152,0	1282		
8SB-97/13R	60	80	EMC/8 80		2865	116	447	0,85	0,86	0,86	0,68	0,76	0,87	160,0	1341		
8SB-97/15R	66	90	EMC/8 90		2865	130	500	0,85	0,86	0,86	0,68	0,76	0,87	169,0	1366		
8SB-97/16	75	100	EMC/8 100		2865	145	560	0,84	0,85	0,85	0,71	0,78	0,88	190,0	1391		
8SB-97/18..20	92	125	EMC/8 125		2835	178	686	0,85	0,86	0,86	0,68	0,76	0,87	55	208,0	1536	

Más información en fichas técnicas motores sumergibles EMC • More information in technicals specifications of sumersible motors EMC

Cuerpo • Body

Rodete • Impeller

Eje Bomba y Acople • Pump shaft and Coupling

Rejilla y Válvula • Strainer and Valve cap

Diám. Impulsión • Outlet con. diam.

Max. Contenido Arena • Max. Sand Content

Fundición de Hierro GG-25 • Cast Iron GG-25

Bronce • Bronze

Acero Inoxidable AISI 420 • Stainless Steel AISI 420

Acero Inoxidable AISI 304 • Stainless Steel AISI 304

DN120 • DN120

50 gr/m³ • 50 gr/m³

50Hz

Bombas Fundición de Hierro - Rodete en Bronce

Cast Iron Pumps - Impeller in Bronze

8SB 97

Características 50Hz • Performance 50Hz

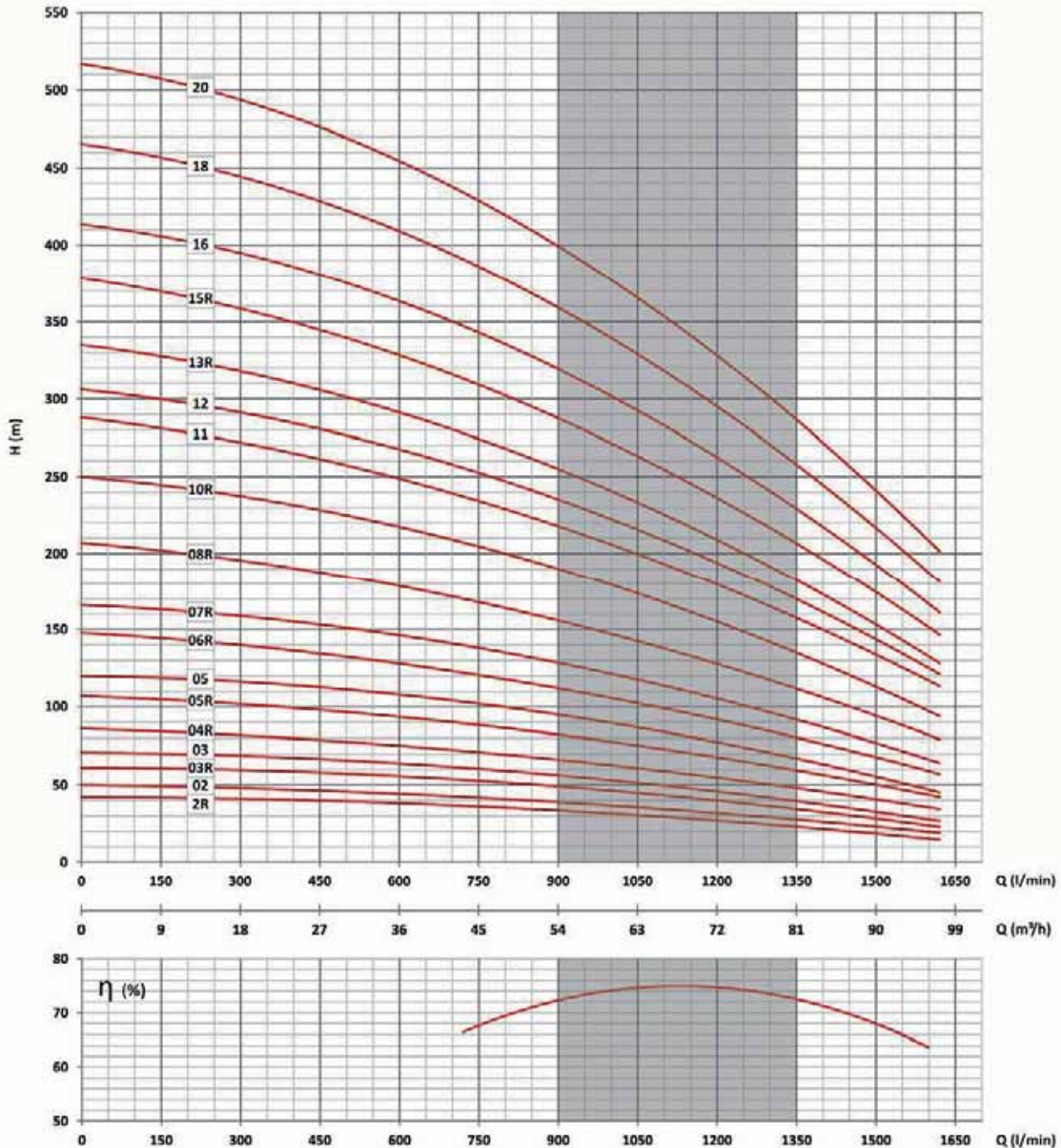

Dimensiones y pesos en páginas posteriores • Dimensions and weights in subsequent pages

Las condiciones de trabajo han sido tomadas en las siguientes condiciones: agua 15°C, presión atmosférica de 1 bar y densidad específica 1gr/cm³ según ISO 9906 Annex A.
The hydraulic working characteristics have been taken with water at 15°C, at the atmospheric pressure of 1 bar and specific gravity is 1gr/cm³, ISO 9906 Annex A.

8SB 72

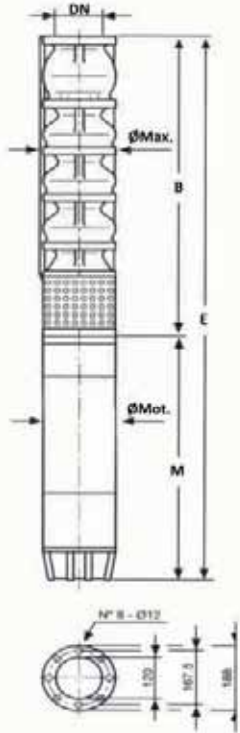
Dimensiones y Pesos • Dimensions and Weights

Dimensiones y peso de la bomba • Pump weight and dimensions							
Tipo Type	E	B	M	ØMax	ØMot.	DN	Peso Bomba Pump Weight
8SB-72/1	1256	607	649	200	144	120	40
8SB-72/2	1501	743	758				52
8SB-72/3	1730	879	851				64
8SB-72/4R	1926	1015	911				76
8SB-72/5R	2124	1151	973				88
8SB-72/6R	2293	1287	1006				100
8SB-72/7R	2529	1423	1106				112
8SB-72/8R	2776	1559	1217				124
8SB-72/9R	2751	1695	1056				136
8SB-72/10	2947	1831	1116				148
8SB-72/12	3304	2103	1201	172			
8SB-72/14	3661	2375	1286	196			
8SB-72/15	3793	2511	1282	208			
8SB-72/16	3988	2647	1341	220			
8SB-72/18	4285	2919	1366	244			
8SB-72/20	4582	3191	1391	268			

8SB 97

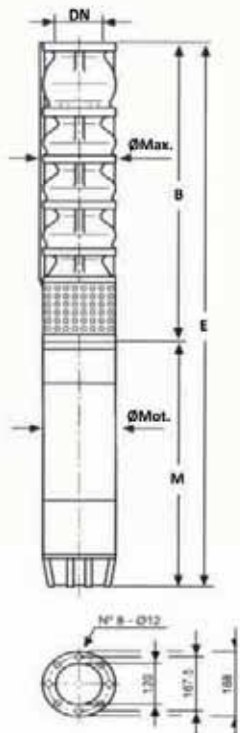
Dimensiones y Pesos • Dimensions and Weights

Dimensiones y peso de la bomba • Pump weight and dimensions							
Tipo Type	E	B	M	ØMax	ØMot.	DN	Peso Bomba Pump Weight
8SB-97/2R	1501	743	758	200	144	120	52
8SB-97/2	1543	743	800				52
8SB-97/3R	1852	879	973				64
8SB-97/3	1885	879	1006				64
8SB-97/4R	2121	1015	1106				76
8SB-97/5R	2368	1151	1217				88
8SB-97/5	2257	1151	1106				88
8SB-97/6R	2504	1287	1217				100
8SB-97/7R	2479	1423	1056				112
8SB-97/8R	2675	1559	1116				124
8SB-97/10R	3032	1831	1201	148			
8SB-97/11	3253	1967	1286	160			
8SB-97/12	3385	2103	1282	172			
8SB-97/13R	3580	2239	1341	184			
8SB-97/15R	3877	2511	1366	208			
8SB-97/16	4038	2647	1391	220			
8SB-97/18	4455	2919	1536	244			
8SB-97/20	4727	3191	1536	268			

8SB 72

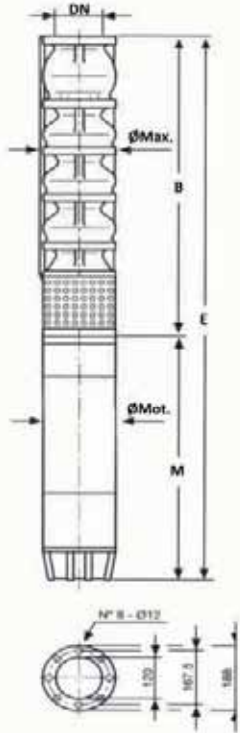
Dimensiones y Pesos • Dimensions and Weights

Dimensiones y peso de la bomba • Pump weight and dimensions							
Tipo Type	E	B	M	ØMax	ØMot.	DN	Peso Bomba Pump Weight
8SB-72/1	1256	607	649	200	144	120	40
8SB-72/2	1501	743	758				52
8SB-72/3	1730	879	851				64
8SB-72/4R	1926	1015	911				76
8SB-72/5R	2124	1151	973				88
8SB-72/6R	2293	1287	1006				100
8SB-72/7R	2529	1423	1106				112
8SB-72/8R	2776	1559	1217				124
8SB-72/9R	2751	1695	1056				136
8SB-72/10	2947	1831	1116				148
8SB-72/12	3304	2103	1201	172			
8SB-72/14	3661	2375	1286	196			
8SB-72/15	3793	2511	1282	208			
8SB-72/16	3988	2647	1341	220			
8SB-72/18	4285	2919	1366	244			
8SB-72/20	4582	3191	1391	268			

8SB 97

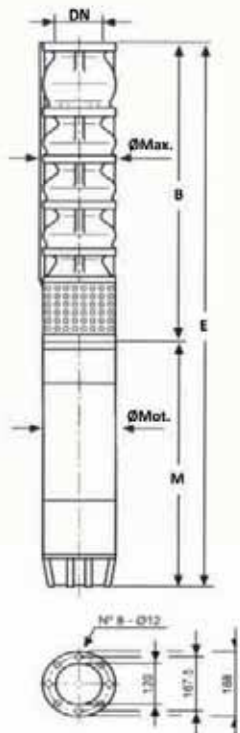
Dimensiones y Pesos • Dimensions and Weights

Dimensiones y peso de la bomba • Pump weight and dimensions							
Tipo Type	E	B	M	ØMax	ØMot.	DN	Peso Bomba Pump Weight
8SB-97/2R	1501	743	758	200	144	120	52
8SB-97/2	1543	743	800				52
8SB-97/3R	1852	879	973				64
8SB-97/3	1885	879	1006				64
8SB-97/4R	2121	1015	1106				76
8SB-97/5R	2368	1151	1217				88
8SB-97/5	2257	1151	1106				88
8SB-97/6R	2504	1287	1217				100
8SB-97/7R	2479	1423	1056				112
8SB-97/8R	2675	1559	1116				124
8SB-97/10R	3032	1831	1201	148			
8SB-97/11	3253	1967	1286	160			
8SB-97/12	3385	2103	1282	172			
8SB-97/13R	3580	2239	1341	184			
8SB-97/15R	3877	2511	1366	208			
8SB-97/16	4038	2647	1391	220			
8SB-97/18	4455	2919	1536	244			
8SB-97/20	4727	3191	1536	268			

50Hz

Bombas Fundición de Hierro - Rodete en Bronce

Cast Iron Pumps - Impeller in Bronze

8SB 118

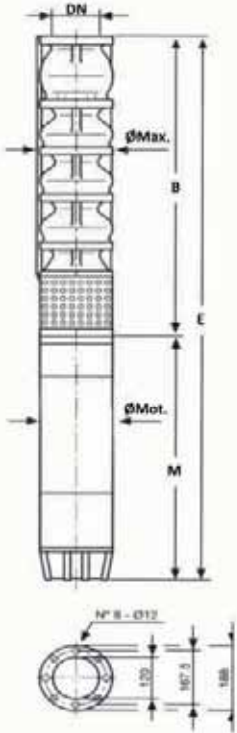

Dimensiones y Pesos • Dimensions and Weights

Dimensiones y peso de la bomba • Pump weight and dimensions							
Tipo Type	E	B	M	ØMax	ØMot.	DN	Peso Bomba Pump Weight
8SB-118/1	1365	607	758	200	144	120	40
8SB-118/2R	1594	743	851				52
8SB-118/2	1849	743	1106				52
8SB-118/3R	1885	879	1006				64
8SB-118/3	1985	879	1106				64
8SB-118/4R	2232	1015	1217				76
8SB-118/4	2071	1015	1056		76		
8SB-118/5	2267	1151	1116		88		
8SB-118/6	2488	1287	1201		100		
8SB-118/7	2709	1423	1286		112		
8SB-118/8	2900	1559	1341		124		
8SB-118/9	3061	1695	1366		136		
8SB-118/10	3222	1831	1391		148		
8SB-118/11	3503	1967	1536	160			
8SB-118/12	3639	2103	1536	172			
8SB-118/13R	3775	2239	1536	184			

8SB 150

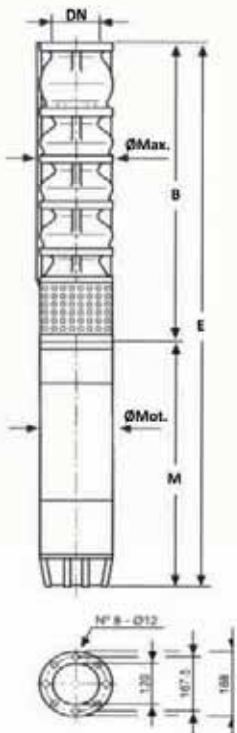

Dimensiones y Pesos • Dimensions and Weights

Dimensiones y peso de la bomba • Pump weight and dimensions							
Tipo Type	E	B	M	ØMax	ØMot.	DN	Peso Bomba Pump Weight
8SB-150/1	1365	607	758	200	144	120	40
8SB-150/2R	1594	743	851				52
8SB-150/2	1849	743	1106				52
8SB-150/3R	1885	879	1006				64
8SB-150/3	1985	879	1106				64
8SB-150/4R	2232	1015	1217				76
8SB-150/4	2071	1015	1056		76		
8SB-150/5	2267	1151	1116		88		
8SB-150/6	2488	1287	1201		100		
8SB-150/7	2709	1423	1286		112		
8SB-150/8R	2841	1559	1282		124		
8SB-150/8	2900	1559	1341		124		
8SB-150/9	3061	1695	1366		136		
8SB-150/10	3222	1831	1391		148		
8SB-150/11	3503	1967	1536		160		
8SB-150/12	3639	2103	1536	172			
8SB-150/13R	3775	2239	1536	189			
8SB-150/15	4021	2511	1510	231	208		

Debido a continuas mejoras en los diseños, EMC BOMBAS se reserva el derecho de realizar modificaciones sin previo aviso.
Due to continuous improvement in design EMC BOMBAS reserves the right to amend specifications or data without prior notice.

8SB 118

Características 50Hz • Performance 50Hz

Bomba Pump	Motor		Q	Caudal • Capacity											
			l/s	0	15,0	17,0	19,0	20,0	23,0	25,0	27,0	29,0	31,0	33,0	
	m ³ /h	0	54,0	61,2	68,4	72,0	82,8	90,0	97,2	104,4	111,6	118,8			
	kW	HP	l/min	0	900	1020	1140	1200	1380	1500	1620	1740	1860	1980	
8SB-118/1	7,5	10	Altura • Head H (m)	32	26	25	24	23	22	21	19	18	16	12	
8SB-118/2R	11	15		52	45	43	41	40	35	32	26	23	17	13	
8SB-118/2	15	20		64	51	49	48	47	44	41	38	35	31	23	
8SB-118/3R	18,5	25		84	71	68	65	63	57	53	45	41	33	25	
8SB-118/3	22	30		96	76	74	72	70	66	62	57	52	46	35	
8SB-118/4R	26	35		116	97	93	89	87	79	74	64	59	49	37	
8SB-118/4	30	40		128	101	98	95	93	87	82	76	69	62	46	
8SB-118/5	37	50		160	126	123	119	117	109	103	95	86	77	64	
8SB-118/6	45	60		192	151	147	143	141	131	123	114	103	92	77	
8SB-118/7	52	70		224	176	172	166	164	152	144	133	120	108	90	
8SB-118/8	60	80		256	201	196	190	187	174	164	152	137	123	103	
8SB-118/9	66	90		288	226	221	214	211	196	185	171	154	138	116	
8SB-118/10	75	100		320	251	245	237	232	217	205	189	171	153	129	
8SB-118/11	92	125	352	277	270	261	256	239	226	208	189	169	142		
8SB-118/12	92	125	384	302	294	285	279	261	246	227	206	184	154		
8SB-118/13R	92	125	404	322	313	302	295	274	258	234	212	186	157		

Información Técnica Motor Sumergible • Technical Information Sumersible

Bomba Pump	Potencia Power		Tipo Motor Motor Type	U _N	Información Motor • Motor information											
					n	I _N	I _A	η			cos φ			Ax.	P	L
	min ⁻¹	(A)			50	75	100	50	75	100	kN	(kg)	(mm)			
8SB-118/1	7,5	10	EMC/6 10	400 V	2860	16,7	65	0,79	0,80	0,80	0,59	0,67	0,81	20	53,0	758
8SB-118/2R	11	15	EMC/6 15		2855	23,6	91	0,82	0,83	0,83	0,63	0,71	0,81		61,0	851
8SB-118/2	15	20	EMC/6 20		2875	32,2	120	0,80	0,81	0,81	0,61	0,69	0,83		86,0	1106
8SB-118/3R	18,5	25	EMC/6 25		2868	40,2	155	0,81	0,82	0,82	0,57	0,66	0,81	27	80,0	1006
8SB-118/3	22	30	EMC/6 30		2875	46,7	180	0,82	0,83	0,83	0,59	0,67	0,82		86,0	1106
8SB-118/4R	26	35	EMC/6 35		2885	54,9	212	0,83	0,84	0,84	0,61	0,69	0,83		90,0	1217
8SB-118/4	30	40	EMC/8 40		2865	59,3	229	0,83	0,84	0,84	0,68	0,76	0,87	45	127,0	1056
8SB-118/5	37	50	EMC/8 50		2875	71,4	276	0,85	0,86	0,86	0,68	0,76	0,87		133,0	1116
8SB-118/6	45	60	EMC/8 60		2864	87	336	0,85	0,86	0,86	0,68	0,76	0,87		140,0	1201
8SB-118/7	52	70	EMC/8 70		2865	99	383	0,85	0,86	0,86	0,71	0,78	0,88	55	146,0	1286
8SB-118/8	60	80	EMC/8 80		2865	116	447	0,85	0,86	0,86	0,68	0,76	0,87		160,0	1341
8SB-118/9	66	90	EMC/8 90		2865	130	500	0,85	0,86	0,86	0,68	0,76	0,87		169,0	1366
8SB-118/10	75	100	EMC/8 100		2865	145	560	0,84	0,85	0,85	0,71	0,78	0,88	55	190,0	1391
8SB-118/11	92	125	EMC/8 125	2835	178	686	0,85	0,86	0,86	0,68	0,76	0,87	208,0		1536	
8SB-118/12	92	125	EMC/8 125	2835	178	686	0,85	0,86	0,86	0,68	0,76	0,87	208,0		1536	
8SB-118/13R	92	125	EMC/8 125	2835	178	686	0,85	0,86	0,86	0,68	0,76	0,87	208,0	1536		

Más información en fichas técnicas motores sumergibles EMC • More information in technicals specifications of sumersible motors EMC

Cuerpo • Body

Rodete • Impeller

Eje Bomba y Acople • Pump shaft and Coupling

Rejilla y Válvula • Strainer and Valve cap

Diám. Impulsión • Outlet con. diam.

Max. Contenido Arena • Max. Sand Content

Fundición de Hierro GG-25 • Cast Iron GG-25

Bronce • Bronze

Acero Inoxidable AISI 420 • Stainless Steel AISI 420

Acero Inoxidable AISI 304 • Stainless Steel AISI 304

DN120 • DN120

50 gr/m³ • 50 gr/m³



50Hz

Bombas Fundición de Hierro - Rodete en Bronce
Cast Iron Pumps - Impeller in Bronze

8SB 118

Características 50Hz • Performance 50Hz

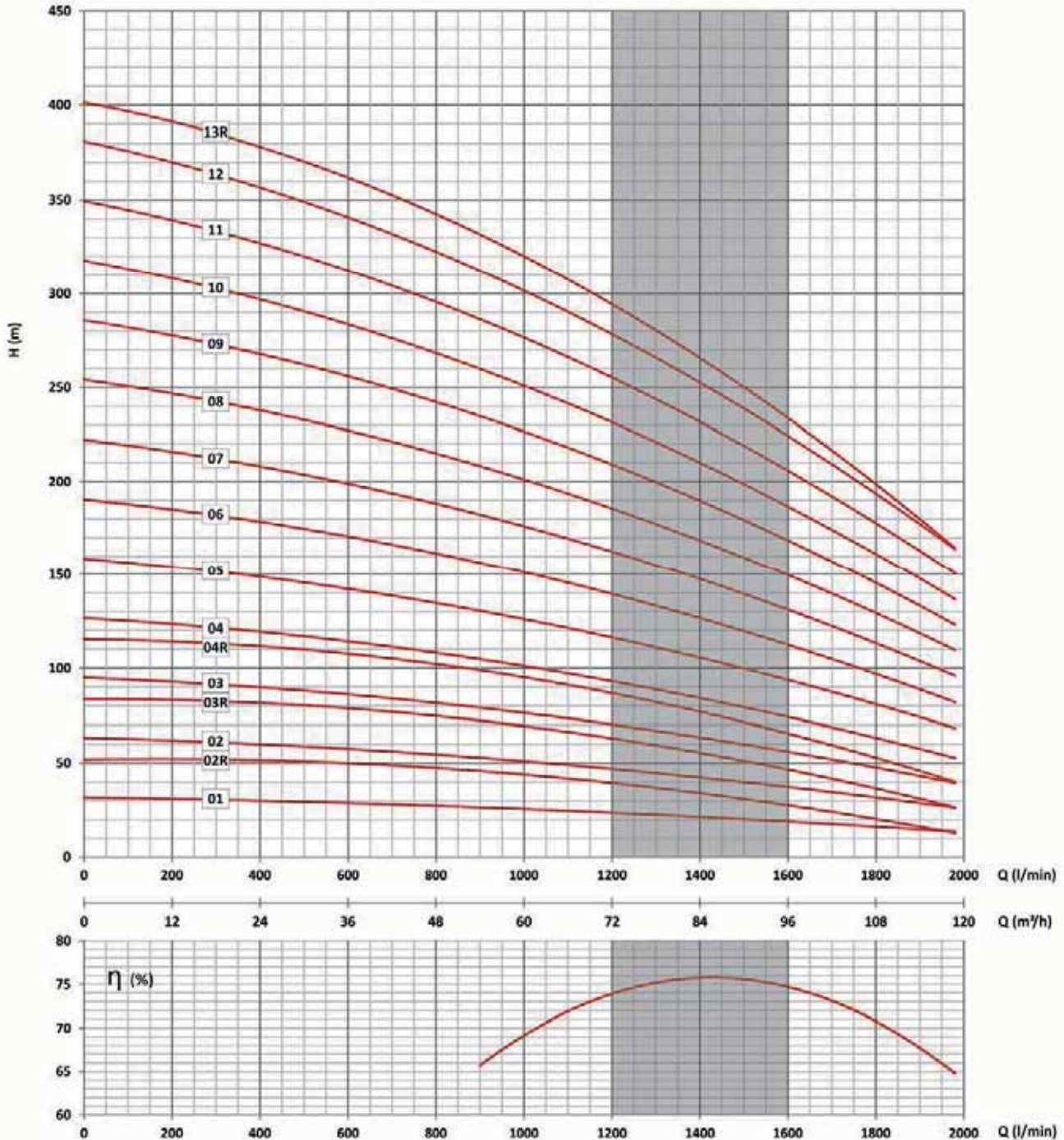

Dimensiones y pesos en páginas posteriores • Dimensions and weights in subsequent pages

Las condiciones de trabajo han sido tomadas en las siguientes condiciones: agua 15°C, presión atmosférica de 1 bar y densidad específica 1gr/cm³ según ISO 9906 Annex A.
The hydraulic working characteristics have been taken with water at 15°C, at the atmospheric pressure of 1 bar and specific gravity is 1gr/cm³, ISO 9906 Annex A.

Debido a continuas mejoras en los diseños, EMC BOMBAS se reserva el derecho de realizar modificaciones sin previo aviso.
Due to continuous improvement in design EMC BOMBAS reserves the right to amend specifications or data without prior notice.

50Hz

Bombas Fundición de Hierro - Rodete en Bronce

Cast Iron Pumps - Impeller in Bronze

8SB 118

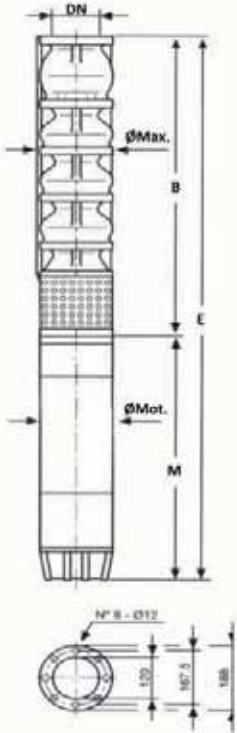

Dimensiones y Pesos • Dimensions and Weights

Dimensiones y peso de la bomba • Pump weight and dimensions							
Tipo Type	E	B	M	ØMax	ØMot.	DN	Peso Bomba Pump Weight
8SB-118/1	1365	607	758	200	144	120	40
8SB-118/2R	1594	743	851				52
8SB-118/2	1849	743	1106				52
8SB-118/3R	1885	879	1006				64
8SB-118/3	1985	879	1106				64
8SB-118/4R	2232	1015	1217				76
8SB-118/4	2071	1015	1056		76		
8SB-118/5	2267	1151	1116		88		
8SB-118/6	2488	1287	1201		100		
8SB-118/7	2709	1423	1286		112		
8SB-118/8	2900	1559	1341		124		
8SB-118/9	3061	1695	1366		136		
8SB-118/10	3222	1831	1391		148		
8SB-118/11	3503	1967	1536	160			
8SB-118/12	3639	2103	1536	172			
8SB-118/13R	3775	2239	1536	184			

8SB 150

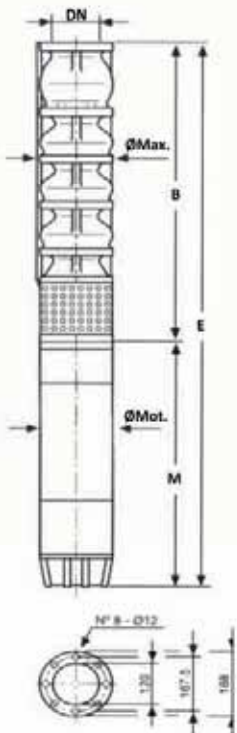

Dimensiones y Pesos • Dimensions and Weights

Dimensiones y peso de la bomba • Pump weight and dimensions							
Tipo Type	E	B	M	ØMax	ØMot.	DN	Peso Bomba Pump Weight
8SB-150/1	1365	607	758	200	144	120	40
8SB-150/2R	1594	743	851				52
8SB-150/2	1849	743	1106				52
8SB-150/3R	1885	879	1006				64
8SB-150/3	1985	879	1106				64
8SB-150/4R	2232	1015	1217				76
8SB-150/4	2071	1015	1056		76		
8SB-150/5	2267	1151	1116		88		
8SB-150/6	2488	1287	1201		100		
8SB-150/7	2709	1423	1286		112		
8SB-150/8R	2841	1559	1282		124		
8SB-150/8	2900	1559	1341		124		
8SB-150/9	3061	1695	1366		136		
8SB-150/10	3222	1831	1391		148		
8SB-150/11	3503	1967	1536		160		
8SB-150/12	3639	2103	1536	172			
8SB-150/13R	3775	2239	1536	189			
8SB-150/15	4021	2511	1510	231	208		

Debido a continuas mejoras en los diseños, EMC BOMBAS se reserva el derecho de realizar modificaciones sin previo aviso.
Due to continuous improvement in design EMC BOMBAS reserves the right to amend specifications or data without prior notice.

8SB 150

Características 50Hz • Performance 50Hz

Bomba Pump	Motor		Q	Caudal • Capacity											
			l/s	0	18	21,0	24,0	26,0	28,0	30,0	33,0	34,0	38,0	40,0	42,0
			m ³ /h	0	65	75,6	86,4	93,6	100,8	108,0	118,8	122,4	136,8	144,0	151,2
		l/min	0	1080	1260	1440	1560	1680	1800	1980	2040	2280	2400	2520	
8SB-150/1	7,5	10	Altura • Head H (m)	28	23	22	21	20	19	18	17	16	13	11	10
8SB-150/2R	11	15		49	36	34	33	32	30	28	24	24	18	15	12
8SB-150/2	15	20		56	46	43	41	40	38	36	33	32	26	23	19
8SB-150/3R	18,5	25		77	59	56	53	51	49	46	41	40	31	26	21
8SB-150/3	22	30		84	69	65	62	60	57	55	50	48	39	34	29
8SB-150/4R	26	35		105	82	78	74	71	68	64	58	56	44	38	31
8SB-150/4	30	40		111	91	87	82	79	76	73	67	65	52	45	39
8SB-150/5	37	50		141	116	110	104	100	96	92	85	82	66	58	49
8SB-150/6	45	60		169	139	131	125	120	115	111	102	99	80	69	59
8SB-150/7	52	70		197	162	153	146	141	135	129	119	115	93	81	69
8SB-150/8R	55	75		218	175	166	158	152	146	139	127	123	98	84	71
8SB-150/8	60	80		225	185	175	167	161	154	148	136	132	106	92	79
8SB-150/9	66	90		253	212	201	191	184	177	169	153	148	120	104	89
8SB-150/10	75	100		281	236	223	213	205	196	188	170	164	133	115	98
8SB-150/11	92	125		310	254	241	229	221	212	203	187	181	146	127	108
8SB-150/12	92	125	338	277	263	250	241	231	222	204	197	160	138	118	
8SB-150/13R	92	125	359	291	276	262	252	242	232	212	205	164	142	120	
8SB-150/15	110	150	422	347	329	313	301	289	277	255	247	200	173	148	

Información Técnica Motor Sumergible • Technical Information Sumersible

Bomba Pump	Potencia Power		Tipo Motor Motor Type	U _N	Información Motor • Motor information										Ax.	P	L
					n	I _N	I _A	η			cos φ						
								min ⁻¹	(A)	50	75	100	50	75			
kW		HP											kN	(kg)	(mm)		
8SB-150/1	7,5	10	EMC/6 10	400 V	2860	16,7	65	0,79	0,80	0,80	0,59	0,67	0,81	20	53,0	758	
8SB-150/2R	11	15	EMC/6 15		2855	23,6	91	0,82	0,83	0,83	0,63	0,71	0,81		61,0	851	
8SB-150/2	15	20	EMC/6 20		2875	32,2	120	0,80	0,81	0,81	0,61	0,69	0,83		86,0	1106	
8SB-150/3R	18,5	25	EMC/6 25		2868	40,2	155	0,81	0,82	0,82	0,57	0,66	0,81	80,0	1006		
8SB-150/3	22	30	EMC/6 30		2875	46,7	180	0,82	0,83	0,83	0,59	0,67	0,82	86,0	1106		
8SB-150/4R	26	35	EMC/6 35		2885	54,9	212	0,83	0,84	0,84	0,61	0,69	0,83	27	90,0	1217	
8SB-150/4	30	40	EMC/8 40		2865	59,3	229	0,83	0,84	0,84	0,68	0,76	0,87		127,0	1056	
8SB-150/5	37	50	EMC/8 50		2875	71,4	276	0,85	0,86	0,86	0,68	0,76	0,87	133,0	1116		
8SB-150/6	45	60	EMC/8 60		2864	86,8	336	0,85	0,86	0,86	0,68	0,76	0,87	140,0	1201		
8SB-150/7	52	70	EMC/8 70		2865	99,0	383	0,85	0,86	0,86	0,71	0,78	0,88	146,0	1286		
8SB-150/8R	55	75	EMC/8 75		2864	108	415	0,83	0,84	0,84	0,71	0,78	0,88	45	152,0	1282	
8SB-150/8	60	80	EMC/8 80		2865	116	447	0,85	0,86	0,86	0,68	0,76	0,87		160,0	1341	
8SB-150/9	66	90	EMC/8 90		2865	130	500	0,85	0,86	0,86	0,68	0,76	0,87	169,0	1366		
8SB-150/10	75	100	EMC/8 100		2865	145	560	0,84	0,85	0,85	0,71	0,78	0,88	190,0	1391		
8SB-150/11..13R	92	125	EMC/8 125		2835	178	686	0,85	0,86	0,86	0,68	0,76	0,87	55	208,0	1536	

Más información en fichas técnicas motores sumergibles EMC • More information in technicals specifications of sumersible motors EMC

Cuerpo • Body

Rodete • Impeller

Eje Bomba y Acople • Pump shaft and Coupling

Rejilla y Válvula • Strainer and Valve cap

Diám. Impulsión • Outlet con. diam.

Max. Contenido Arena • Max. Sand Content

Fundición de Hierro GG-25 • Cast Iron GG-25

Bronce • Bronze

Acero Inoxidable AISI 420 • Stainless Steel AISI 420

Acero Inoxidable AISI 304 • Stainless Steel AISI 304

DN120 • DN120

50 gr/m³ • 50 gr/m³

50Hz

Bombas Fundición de Hierro - Rodete en Bronce

Cast Iron Pumps - Impeller in Bronze

8SB 150

Características 50Hz • Performance 50Hz

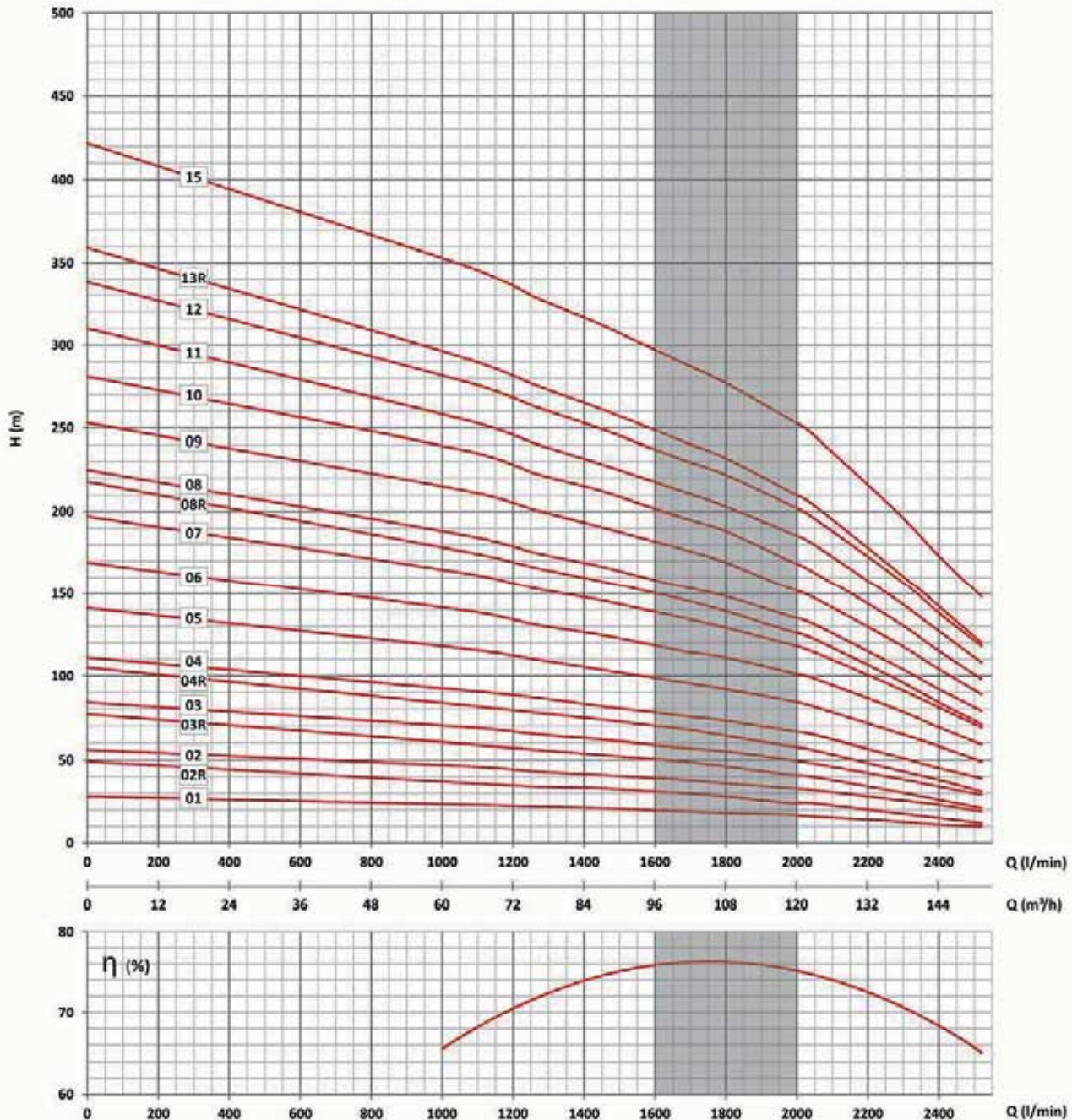

Dimensiones y pesos en páginas posteriores • Dimensions and weights in subsequent pages

Las condiciones de trabajo han sido tomadas en las siguientes condiciones: agua 15°C, presión atmosférica de 1 bar y densidad específica 1gr/cm³ según ISO 9906 Annex A.
The hydraulic working characteristics have been taken with water at 15°C, at the atmospheric pressure of 1 bar and specific gravity is 1gr/cm³, ISO 9906 Annex A.

50Hz

Bombas Fundición de Hierro - Rodete en Bronce

Cast Iron Pumps - Impeller in Bronze

8SB 118

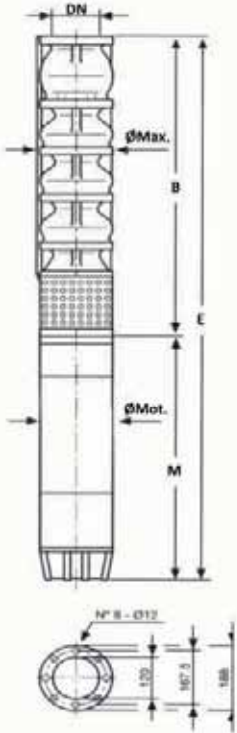

Dimensiones y Pesos • Dimensions and Weights

Dimensiones y peso de la bomba • Pump weight and dimensions							
Tipo Type	E	B	M	ØMax	ØMot.	DN	Peso Bomba Pump Weight
8SB-118/1	1365	607	758	200	144	120	40
8SB-118/2R	1594	743	851				52
8SB-118/2	1849	743	1106				52
8SB-118/3R	1885	879	1006				64
8SB-118/3	1985	879	1106				64
8SB-118/4R	2232	1015	1217				76
8SB-118/4	2071	1015	1056		76		
8SB-118/5	2267	1151	1116		88		
8SB-118/6	2488	1287	1201		100		
8SB-118/7	2709	1423	1286		112		
8SB-118/8	2900	1559	1341		124		
8SB-118/9	3061	1695	1366		136		
8SB-118/10	3222	1831	1391		148		
8SB-118/11	3503	1967	1536	160			
8SB-118/12	3639	2103	1536	172			
8SB-118/13R	3775	2239	1536	184			

8SB 150

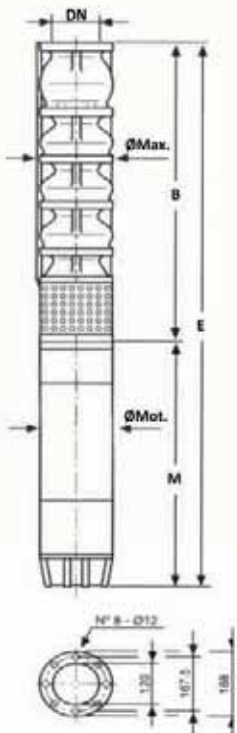

Dimensiones y Pesos • Dimensions and Weights

Dimensiones y peso de la bomba • Pump weight and dimensions							
Tipo Type	E	B	M	ØMax	ØMot.	DN	Peso Bomba Pump Weight
8SB-150/1	1365	607	758	200	144	120	40
8SB-150/2R	1594	743	851				52
8SB-150/2	1849	743	1106				52
8SB-150/3R	1885	879	1006				64
8SB-150/3	1985	879	1106				64
8SB-150/4R	2232	1015	1217				76
8SB-150/4	2071	1015	1056		76		
8SB-150/5	2267	1151	1116		88		
8SB-150/6	2488	1287	1201		100		
8SB-150/7	2709	1423	1286		112		
8SB-150/8R	2841	1559	1282		124		
8SB-150/8	2900	1559	1341		124		
8SB-150/9	3061	1695	1366		136		
8SB-150/10	3222	1831	1391		148		
8SB-150/11	3503	1967	1536		160		
8SB-150/12	3639	2103	1536	172			
8SB-150/13R	3775	2239	1536	189			
8SB-150/15	4021	2511	1510	231	208		

Debido a continuas mejoras en los diseños, EMC BOMBAS se reserva el derecho de realizar modificaciones sin previo aviso.
Due to continuous improvement in design EMC BOMBAS reserves the right to amend specifications or data without prior notice.

8SB 200

Características 50Hz • Performance 50Hz

Bomba Pump	Motor		Q	Caudal • Capacity												
			l/s	0	25	29,0	33,0	38,0	40,0	42,5	45,0	47,5	50,0	53,0	57,0	
			m ³ /h	0	90	104,4	118,8	136,8	144,0	153,0	162,0	171,0	180,0	190,8	205,2	
		kW	HP	l/min	0	1500	1740	1980	2280	2400	2550	2700	2850	3000	3180	3420
8SB-200/1R	7,5	10	Altura • Head H (m)	23	18	17	16	15	14	13	12	11	9	8	5	
8SB-200/1	9,2	12,5		26	21	20	18	17	16	15	14	13	11	9	6	
8SB-200/2R	15	20		47	37	35	32	29	28	25	23	21	19	16	11	
8SB-200/2	18,5	25		52	41	39	37	34	32	30	27	25	22	18	13	
8SB-200/3R	22	30		70	56	52	49	44	41	38	35	32	28	24	16	
8SB-200/3	26	35		77	62	59	56	50	48	45	41	37	33	28	19	
8SB-200/4R	30	40		94	74	70	65	58	55	51	47	43	38	32	22	
8SB-200/4	37	50		103	82	79	74	67	64	60	55	50	44	37	26	
8SB-200/5R	37	50		117	93	87	81	73	69	64	59	53	47	40	27	
8SB-200/6S	45	60		141	113	107	100	90	85	79	72	65	58	48	37	
8SB-200/6R	45	70		153	124	117	110	100	95	89	81	74	66	54	43	
8SB-200/7R	52	75		170	137	130	122	110	104	97	88	80	71	59	46	
8SB-200/7S	55	80		176	142	135	127	115	109	102	93	84	75	62	49	
8SB-200/8R	60	90		200	161	153	144	130	123	115	105	95	85	70	56	
8SB-200/9R	66	100	223	180	171	161	145	137	129	117	106	95	78	62		
8SB-200/10	75	125	265	215	204	192	175	167	156	142	129	116	96	77		
8SB-200/11R	92	125	276	223	212	199	180	171	160	145	132	118	98	77		
8SB-200/13R	92	150	329	266	253	237	215	204	191	174	158	141	117	92		

Información Técnica Motor Sumergible • Technical Information Sumersible

Bomba Pump	Potencia Power		Tipo Motor Motor Type	U _N	Información Motor • Motor Information											
					n min ⁻¹	I _N	I _A	η			cos φ			Ax. kN	P (kg)	L (mm)
								50	75	100	50	75	100			
8SB-200/1R	7,5	10	EMC/6 10	400 V	2860	16,7	65	0,79	0,80	0,80	0,59	0,67	0,81	20	53,0	758
8SB-200/1	9,2	12,5	EMC/6 12,5		2865	20,5	79	0,80	0,81	0,81	0,59	0,67	0,81		57,0	800
8SB-200/2R	15	20	EMC/6 20		2875	32,2	120	0,80	0,81	0,81	0,61	0,69	0,83	86,0	1106	
8SB-200/2	18,5	25	EMC/6 25		2868	40,2	155	0,81	0,82	0,82	0,57	0,66	0,81	80,0	1006	
8SB-200/3R	22	30	EMC/6 30		2875	46,7	180	0,82	0,83	0,83	0,59	0,67	0,82	86,0	1106	
8SB-200/3	26	35	EMC/6 35		2885	54,9	212	0,83	0,84	0,84	0,61	0,69	0,83	27	90,0	1217
8SB-200/4R	30	40	EMC/8 40		2865	59,3	229	0,83	0,84	0,84	0,68	0,76	0,87	45	127,0	1056
8SB-200/4..5R	37	50	EMC/8 50		2875	71,4	276	0,85	0,86	0,86	0,68	0,76	0,87		133,0	1116
8SB-200/6S	45	60	EMC/8 60		2864	86,8	336	0,85	0,86	0,86	0,68	0,76	0,87	140,0	1201	
8SB-200/6R	45	70	EMC/8 70		2865	99	383	0,85	0,86	0,86	0,71	0,78	0,88	146	1286	
8SB-200/7R	52	75	EMC/8 75		2864	108	415	0,83	0,84	0,84	0,71	0,78	0,88	152	1282	
8SB-200/7S	55	80	EMC/8 80		2865	116	447	0,85	0,86	0,86	0,68	0,76	0,87	160	1341	
8SB-200/8R	60	90	EMC/8 90		2865	130	500	0,85	0,86	0,86	0,68	0,76	0,87	169	1366	
8SB-200/9R	66	100	EMC/8 100		2865	145	560	0,84	0,85	0,85	0,71	0,78	0,88	190	1391	
8SB-200/10..11R	75	125	EMC/8 125	2835	178	686	0,85	0,86	0,86	0,68	0,76	0,87	55	208	1536	
8SB-200/13R	92	150	EMC/10 150	2905	210	811	0,85	0,86	0,86	0,71	0,78	0,88	75	299	1510	

Más información en fichas técnicas motores sumergibles EMC • More information in technicals specifications of sumersible motors EMC

Cuerpo • Body

Rodete • Impeller

Eje Bomba y Acople • Pump shaft and Coupling

Rejilla y Válvula • Strainer and Valve cap

Diám. Impulsión • Outlet con. diam.

Max. Contenido Arena • Max. Sand Content

Fundición de Hierro GG-25 • Cast Iron GG-25

Bronce • Bronze

Acero Inoxidable AISI 420 • Stainless Steel AISI 420

Acero Inoxidable AISI 304 • Stainless Steel AISI 304

DN120 • DN120

50 gr/m³ • 50 gr/m³

50Hz

Bombas Fundición de Hierro - Rodete en Bronce

Cast Iron Pumps - Impeller in Bronze

8SB 200

Características 50Hz • Performance 50Hz

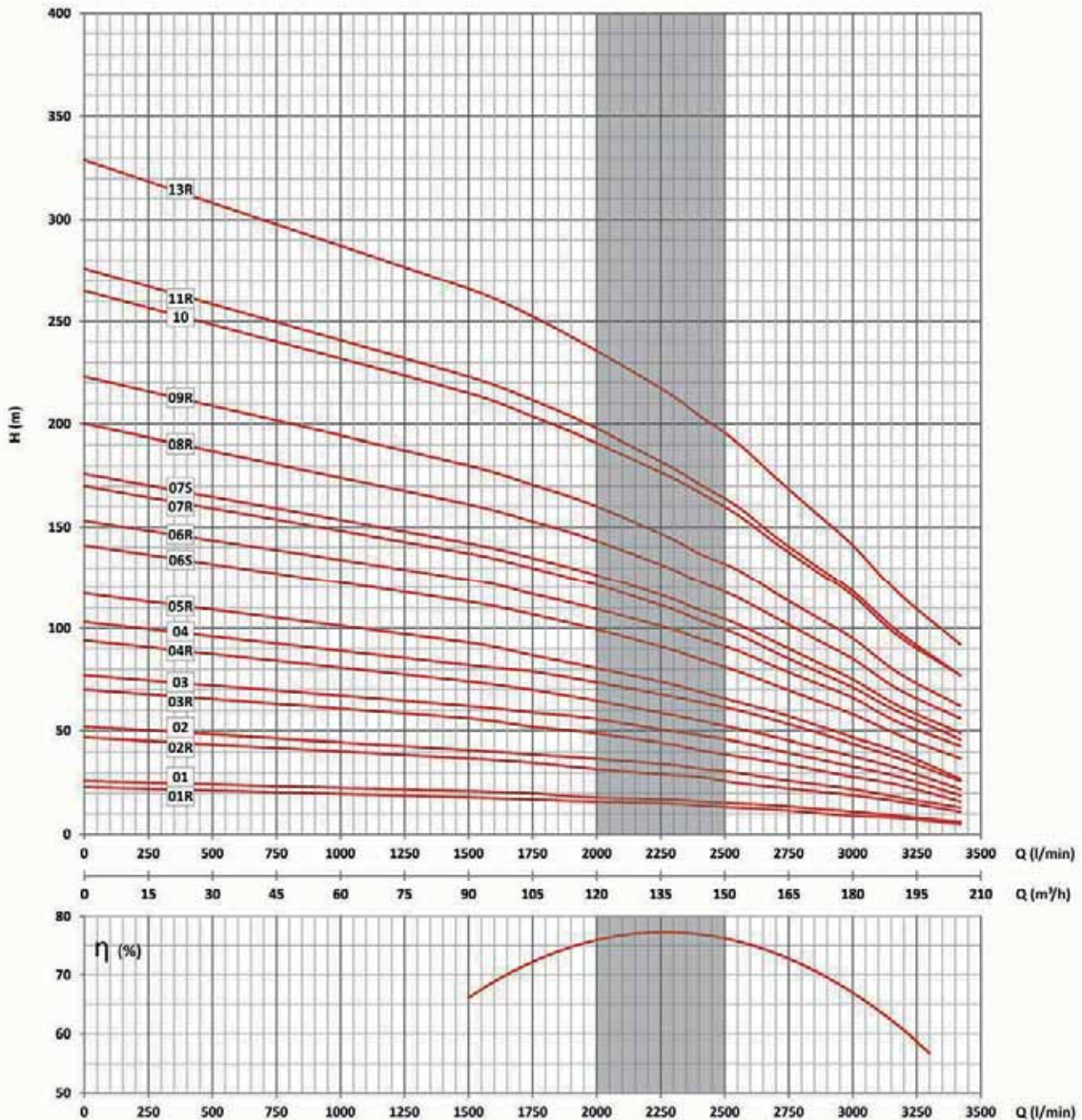

Dimensiones y pesos en páginas posteriores • Dimensions and weights in subsequent pages

Las condiciones de trabajo han sido tomadas en las siguientes condiciones: agua 15°C, presión atmosférica de 1 bar y densidad específica 1gr/cm³ según ISO 9906 Annex A.
The hydraulic working characteristics have been taken with water at 15°C, at the atmospheric pressure of 1 bar and specific gravity is 1gr/cm³, ISO 9906 Annex A.

8SB 200

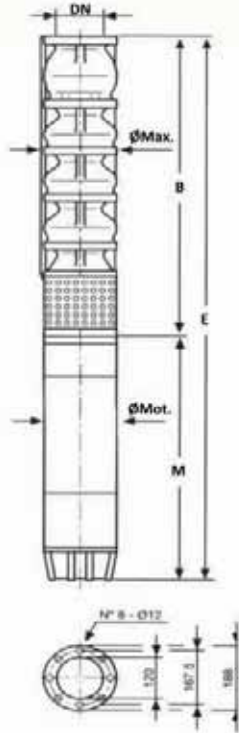
Dimensiones y Pesos • Dimensions and Weights

Dimensiones y peso de la bomba • Pump weight and dimensions							
Tipo Type	E	B	M	ØMax	ØMot.	DN	Peso Bomba Pump Weight
8SB-200/1R	1365	607	758	200	144	120	40
8SB-200/1	1543	743	800				40
8SB-200/2R	1849	743	1106				52
8SB-200/2	1749	743	1006				52
8SB-200/3R	1985	879	1106				64
8SB-200/3	2096	879	1217				64
8SB-200/4R	2071	1015	1056		76		
8SB-200/4	2131	1015	1116		76		
8SB-200/5R	2267	1151	1116		88		
8SB-200/6S	2488	1287	1201		100		
8SB-200/6R	2573	1287	1286		100		
8SB-200/7R	2705	1423	1282		112		
8SB-200/7S	2764	1423	1341		112		
8SB-200/8R	2925	1559	1366	124			
8SB-200/9R	3086	1695	1391	136			
8SB-200/10	3367	1831	1536	148			
8SB-200/11R	3503	1967	1536	160			
8SB-200/13R	3749	2239	1510	231	184		

Las condiciones de trabajo han sido tomadas en las siguientes condiciones: agua 15°C, presión atmosférica de 1 bar y densidad específica 1gr/cm³ según ISO 9906 Annex A.
 The hydraulic working characteristics have been taken with water at: 15°C, at the atmospheric pressure of 1 bar and specific gravity is 1gr/cm³, ISO 9906 Annex A.