



Bombas Fundición de Hierro - Rodete en Hierro

Cast Iron Pumps - Impeller in Iron

50Hz

6SF

BOMBA 6SF

Caudales hasta 90 m³/h a 2850rpm

Altura manométrica hasta 330m a 2850rpm

Impulsiones de 3"y 4"

Ensayos de acuerdo con norma ISO 9906

6SF PUMP

- Capacity up to 90m³/h for 2850rpm

- Head up to 330m for 2850rpm

- Outlet 3" and 4"

- Test according ISO 9906

MOTORES SUMERGIBLES EMC

Motores Sumergibles Rebobinables EMC de 6" hasta 50 CV

Tensión Trifásica 230-400/690V - 50Hz - Tolerancia ±10%

Protección IP 68 - Clase de Aislamiento Tipo F

Temperatura máxima del agua 30°C (Opcional temp. máx. 70°C)

Instalación en Vertical y en Horizontal

Arranque máximos por hora 20

Velocidad mínima de refrigeración hasta 25 CV: 0.2 m/s

Velocidad mínima de refrigeración 30-50 CV: 0.5 m/s

Acoplamiento NEMA

EMC SUBMERSIBLE MOTORS

- 6" Rewindable Submersible Motors EMC up to 50 CV

- Triphase Voltage 230-400/690V - 50Hz - ±10% Tolerance

- IP 68 - Isolament F type

- Water Maximum Temperatura 30°C (Optional 70°C)

- The motor can operate vertically and horizontally

- Maximun start/hour 20

- Minimum cooling water speed up to 25 CV: 0.2 m/s

- Minimum cooling water speed up to 30-50 CV: 0.5 m/s

- NEMA coupling

CARACTERÍSTICAS

Electrobomba sumergible centrífuga multicelular fabricadas en fundición de hierro GG25

Cuerpos de aspiración y de impulsión fabricados en fundición de hierro GG25

Impulsores y difusores fabricados en fundición GG25

Tornillería y rejilla en AISI 304

Válvula de retención y protección de cable en AISI 304

Eje y acoplamiento motor en AISI 304

Acoplamiento norma NEMA 1-18-388

CHARACTERISTICS

- Submersible Centrifugal pump in cast iron

- Suction and discharge case in cast iron GG25

- Impellers and diffusers in cast iron GG25

- Screw and filter in AISI 304

- Check-valve and cable guard in AISI 304

- Shaft and motor coupling in AISI 304

- NEMA 1-18-388 coupling

APLICACIONES

Bombas para aplicaciones en bombeos de aguas de pozos, depósitos, ríos, lagos.

Abastecimiento de agua, riego, sistemas contraincendios, aplicaciones industriales, sistemas de presurización.

APPLICATIONS

- Pumps for pumping in well water, lakes, river.

- Domestic and civil water supply, irrigation, fire-fighting, industrial applications and pressure system.

* Bajo pedido se pueden fabricar con rodetes en Bronce • Under command the impeller can be manufactured in Bronze

50Hz

Bombas Fundición de Hierro - Rodete en Hierro

Cast Iron Pumps - Impeller in Iron

6SF

DESPIECE • CUTTING

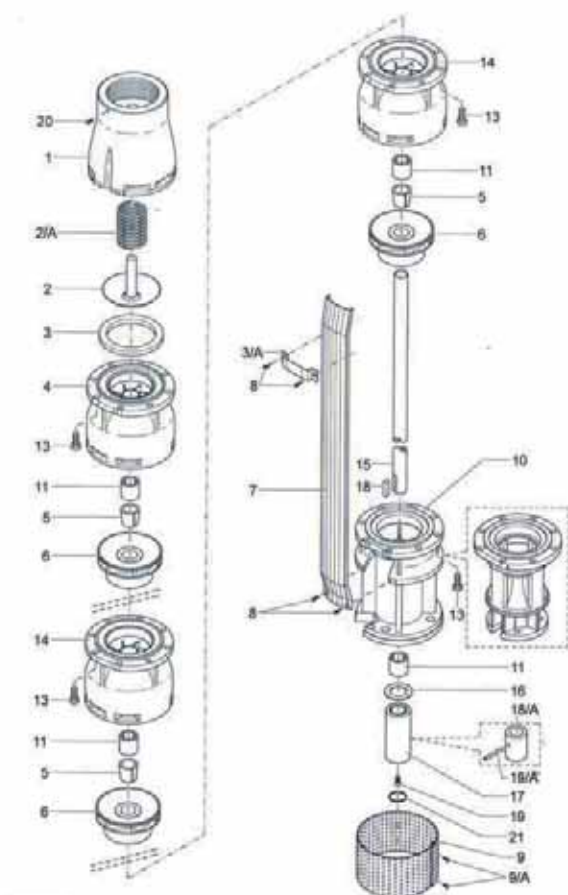

Nº	DESCRIPCIÓN DESCRIPTION	MATERIAL MATERIAL
1	Cuerpo impulsión Discharge Case	Fundición de Hierro Cast Iron
2A	Muelle Válvula Valve Spring	Acero Inoxidable AISI 304 Stainless Steel AISI 304
2	Hongo Válvula Check Valve	Acero Inoxidable AISI 304 Stainless Steel AISI 304
3A	Abrazadera Protec. Cable Cable guard clamp	Acero Inoxidable AISI 304 Stainless Steel AISI 304
3	Asiento Válvula Goma Valve Gasket Ring	Goma Rubber
4	Difusor Descarga Upper Diffuser	Fundición de Hierro Cast Iron
5	Cono fija rodete Conic lock sleeve	Acero Inoxidable AISI 400 Stainless Steel AISI 400
6	Rodete Impeller	Bronce Bronze
7	Protección Cable Cable Guard	Acero Inoxidable AISI 304 Stainless Steel AISI 304
8	Tornillo Protección Cable Screw cable Guard	Acero Inoxidable AISI 304 Stainless Steel AISI 304
9	Filtro de aspiración Suction Filter	Acero Inoxidable AISI 304 Stainless Steel AISI 304
9A	Tornillo filtro Screw for filter	Acero Inoxidable AISI 304 Stainless Steel AISI 304
10	Soporte de aspiración Suction Casing	Fundición de Hierro Cast Iron
11	Cojinete bomba Bearing bush	Acero + Goma Steel + Rubber

Nº	DESCRIPCIÓN DESCRIPTION	MATERIAL MATERIAL
12	Junta Torica Gasket	Goma Rubber
13	Tornillo Screw	Acero Inoxidable AISI 304 Stainless Steel AISI 304
14	Difusor Diffuser	Fundición de Hierro Cast Iron
15	Eje Shaft	Acero Inoxidable AISI 420 Stainless Steel AISI 420
16	Disco contraempuje Counterthrust plate	Teflón Grafitado Graphited Teflon
16A	Brida de aspiración Suction Flange	Fundición de Hierro Cast Iron
17	Manguito Coupling	Acero Inoxidable AISI 400 Stainless Steel AISI 400
17A	Tornillo Brida Aspiración Screw for suction flange	Acero Inoxidable AISI 304 Stainless Steel AISI 304
18	Chaveta Key	Acero Inoxidable AISI 304 Stainless Steel AISI 304
18A	Manguito 4" 4" Coupling	Acero Inoxidable AISI 400 Stainless Steel AISI 400
19A	Clavija Manguito Coupling pin	Acero Inoxidable AISI 304 Stainless Steel AISI 304
19	Tornillo Manguito Coupling Screw	Acero Inoxidable AISI 304 Stainless Steel AISI 304
20	Tornillo de Bloqueo Stop Screw	Acero Inoxidable AISI 304 Stainless Steel AISI 304
21	Junta Torica Manguito Coupling O'ring	Goma Rubber

Debido a continuas mejoras en los diseños, EMC BOMBAS se reserva el derecho de realizar modificaciones sin previo aviso.
Due to continuous improvement in design EMC BOMBAS reserves the right to amend specifications or data without prior notice.

Características 50Hz • Performance 50Hz

Bomba Pump	Motor		Q	Caudal • Capacity												
			l/s	0	6,7	7,5	8,3	9,2	10,0	10,8	11,7	12,9	14,2	15,8	17,5	
			m ³ /h	0	24,0	27,0	30,0	33,0	36,0	39,0	42,0	46,5	51,0	57,0	63,0	
		kW	HP	l/min	0	400	450	500	550	600	650	700	775	850	950	1050
6SF-50/02	4	5,5	Altura • Head H (m)	31	26	25	24	24	23	22	21	20	18	16	13	
6SF-50/03	5,5	7,5		46	39	38	36	35	34	33	32	30	27	24	19	
6SF-50/04	7,5	10		61	51	50	49	47	45	44	42	39	36	32	26	
6SF-50/05	9,3	12,5		77	64	63	61	59	56	55	53	50	46	40	32	
6SF-50/06	11	15		92	77	75	73	71	68	66	63	59	55	48	38	
6SF-50/07	13	17,5		108	90	88	85	82	79	77	74	69	64	56	45	
6SF-50/08	15	20		123	103	100	97	94	90	87	84	79	73	64	51	
6SF-50/09	18,5	25		138	116	113	109	106	102	99	95	89	82	72	58	
6SF-50/10	18,5	25		154	129	125	121	117	113	109	105	98	91	80	64	
6SF-50/11	22	30		169	141	138	134	129	124	120	116	108	100	88	70	
6SF-50/12	26	35		184	154	150	146	141	135	131	126	118	109	96	77	
6SF-50/13	26	35		200	167	163	158	153	147	142	137	128	119	104	83	
6SF-50/14	30	40		215	180	175	170	164	158	153	147	138	128	112	90	
6SF-50/15	30	40		227	192	186	180	174	168	162	156	147	137	120	96	
6SF-50/16	30	40		243	205	199	192	186	179	173	166	156	146	128	102	
6SF-50/17	37	50		258	218	211	204	197	190	184	177	166	155	136	109	
6SF-50/18	37	50		273	230	223	216	209	202	195	187	176	164	144	115	
6SF-50/19	37	50		288	243	236	228	221	213	206	198	186	173	152	122	
6SF-50/20	37	50		303	256	248	240	232	224	216	208	195	182	160	128	
6SF-50/21	37	50		318	269	261	252	244	235	227	218	205	192	168	134	
6SF-50/22	45	60		334	282	273	264	255	246	238	229	215	201	176	141	
6SF-50/23	45	60		349	294	285	276	267	258	249	239	225	210	184	147	
6SF-50/24	45	60		364	307	298	288	279	269	260	250	235	219	192	154	
6SF-50/25	45	60		379	320	310	300	290	280	270	260	244	228	200	160	

Información Técnica Motor Sumergible • Technical Information Sumersible

Bomba Pump	Potencia Power		Tipo Motor Motor Type	U _N	Información Motor • Motor information										Ax.	P	L
					n	I _N	I _A	η			cos φ						
								min ⁻¹	(A)	50	75	100	50	75			
kW	HP	400 V	2855	9,9	38	0,68	0,72	0,72	0,59	0,67	0,81	20	(kg)	(mm)			
6SF-50/02	4	5,5	EMC/6 5,5	400 V	2855	9,9	38	0,68	0,72	0,72	0,59	0,67	0,81	44,0	649		
6SF-50/03	5,5	7,5	EMC/6 7,5		2857	13,3	51	0,71	0,74	0,76	0,59	0,67	0,81	47,0	678		
6SF-50/04	7,5	10	EMC/6 10		2860	16,7	64,5	0,79	0,80	0,80	0,59	0,67	0,81	53,0	758		
6SF-50/05	9,3	12,5	EMC/6 12,5		2865	20,5	79,2	0,80	0,81	0,81	0,59	0,67	0,81	57,0	800		
6SF-50/06	11	15	EMC/6 15		2855	23,6	91,1	0,82	0,83	0,83	0,63	0,71	0,81	61,0	851		
6SF-50/07	13	17,5	EMC/6 17,5		2875	27,9	107,0	0,81	0,82	0,82	0,61	0,69	0,82	66,0	911		
6SF-50/08	15	20	EMC/6 20		2880	32,2	120,0	0,80	0,81	0,81	0,61	0,69	0,83	72,0	973		
6SF-50/09..10	18,5	25	EMC/6 25		2868	40,2	155	0,81	0,82	0,82	0,57	0,66	0,81	80,0	1006		
6SF-50/11	22	30	EMC/6 30		2875	46,7	180	0,82	0,83	0,83	0,59	0,67	0,82	86,0	1106		
6SF-50/12..13	26	35	EMC/6 35		2885	54,9	212	0,83	0,84	0,84	0,61	0,69	0,83	90,0	1217		
6SF-50/14..16	30	40	EMC/6 40		2895	62,1	240	0,83	0,84	0,84	0,61	0,69	0,83	104,0	1247		
6SF-50/17..21	37	50	EMC/6 50		2905	78,5	303	0,81	0,82	0,84	0,61	0,69	0,83	111,0	1347		
6SF-50/22..25	45	60	EMC/7 60		2890	88,0	446	0,84	0,86	0,86	0,75	0,83	0,86	142,0	1139		

Más información en fichas técnicas motores sumergibles EMC • More information in technicals specifications of sumersible motors EMC

Cuerpo y Rodete • Body and Impeller

Eje Bomba y Acople • Pump shaft and Coupling

Rejilla y Válvula • Strainer and Valve cap

Diám. Impulsión • Outlet con. diam.

Max. Contenido Arena • Max. Sand Content

Fundición de Hierro GG-25 • Cast Iron GG-25

Acero Inoxidable • Stainless Steel

Acero Inoxidable • Stainless Steel

3" (rosca interior) • 3" (inside threaded)

50 gr/m³ • 50 gr/m³



50Hz

Bombas Fundición de Hierro - Rodete en Hierro
Cast Iron Pumps - Impeller in Iron

6SF 50

Características 50Hz • Performance 50Hz

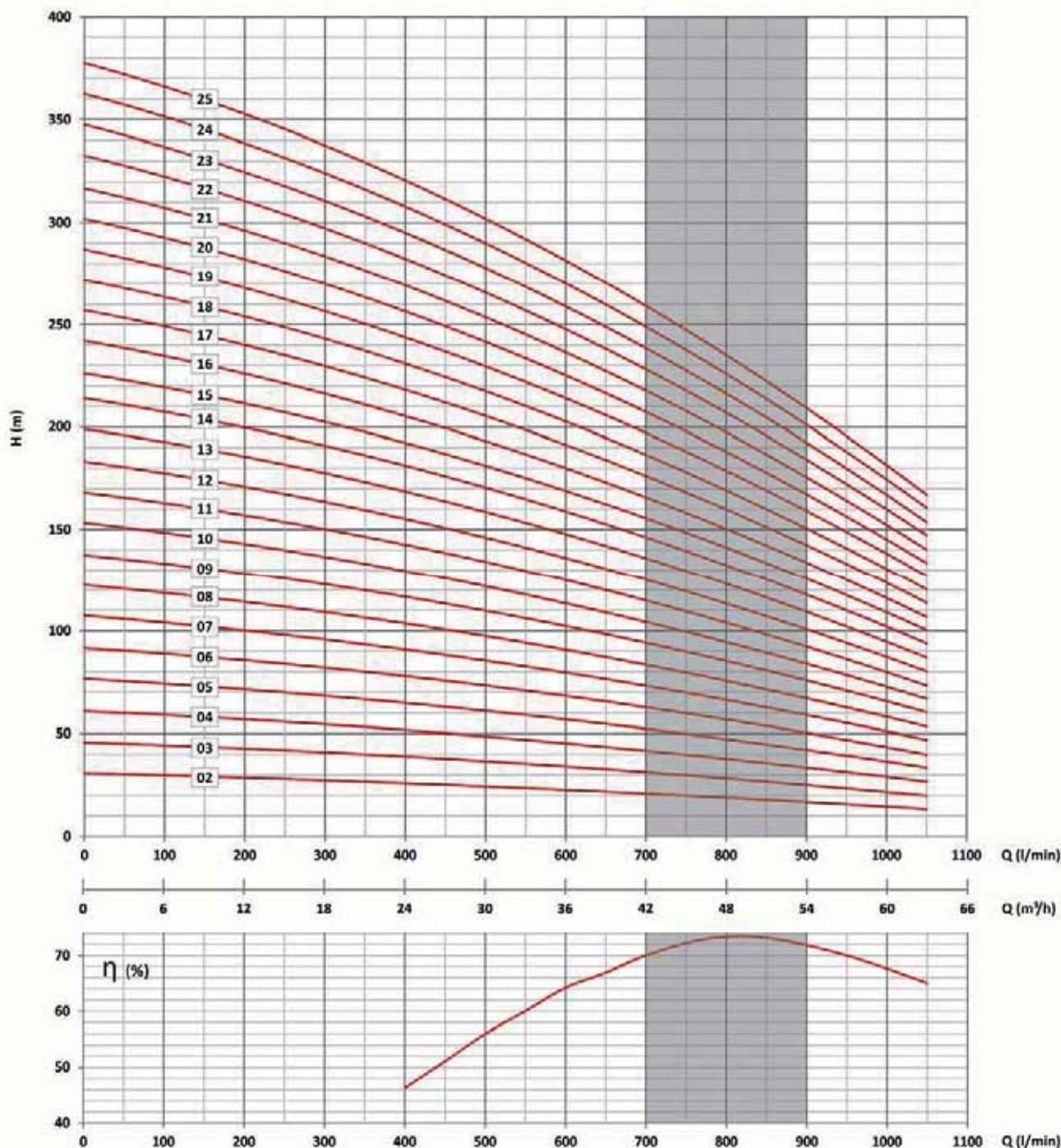

Dimensiones y pesos en páginas posteriores • Dimensions and weights in subsequent pages

Las condiciones de trabajo han sido tomadas en las siguientes condiciones: agua 15°C, presión atmosférica de 1 bar y densidad específica 1gr/cm³ según ISO 9906 Annex A.
 The hydraulic working characteristics have been taken with water at 15°C, at the atmospheric pressure of 1 bar and specific gravity is 1gr/cm³, ISO 9906 Annex A.

6SF 60

Características 50Hz • Performance 50Hz

Bomba Pump	Motor		Q	Caudal • Capacity											
			l/s	0	8,3	10,0	11,7	14,2	16,7	17,5	18,3	19,2	20,0	20,8	21,7
	m ³ /h	0	30,0	36,0	42,0	51,0	60,0	63,0	66,0	69,0	72,0	75,0	78,0		
	l/min	0	500	600	700	850	1000	1050	1100	1150	1200	1250	1300		
Altura • Head H (m)	kW	HP	29	24	23	21	19	17	16	15	14	12	11	10	
	6SF-60/02R	4	5,5	44	35	34	32	29	25	24	22	21	19	17	15
	6SF-60/03R	5,5	7,5	58	47	45	42	38	33	31	29	27	25	23	20
	6SF-60/04R	7,5	10	73	59	56	53	48	42	40	37	34	31	28	25
	6SF-60/05R	9,3	12,5	87	71	67	63	57	50	47	44	41	37	33	29
	6SF-60/06R	11	15	102	83	79	74	67	58	55	51	47	43	39	34
	6SF-60/07R	13	17,5	116	94	89	84	76	66	62	58	54	50	45	39
	6SF-60/08R	15	20	140	114	108	101	90	76	71	66	60	54	48	41
	6SF-60/09	18,5	25	145	118	112	105	95	83	78	73	68	62	56	49
	6SF-60/10R	18,5	25	171	139	131	123	109	92	86	80	73	66	59	51
	6SF-60/11	22	30	186	152	143	134	119	101	95	88	80	72	64	55
	6SF-60/12	26	35	202	164	155	146	129	109	102	95	87	78	69	60
	6SF-60/13	26	35	217	177	167	157	139	118	110	102	93	84	74	64
	6SF-60/14	30	40	233	190	179	168	149	126	118	110	100	90	80	69
	6SF-60/15	30	40	248	202	191	179	159	134	126	117	107	96	85	74
	6SF-60/16	37	50	264	215	203	190	169	143	134	124	113	102	90	78
	6SF-60/17	37	50	279	228	215	202	179	151	141	131	120	108	96	83
	6SF-60/18	37	50	295	240	227	213	189	160	150	139	127	114	101	87
	6SF-60/19	37	50	310	253	239	224	199	168	157	146	133	120	106	92
	6SF-60/20	45	60	326	266	251	235	209	176	165	153	140	126	112	97
	6SF-60/21	45	60	341	278	262	246	219	185	173	161	147	132	117	101
	6SF-60/22	45	60												

Información Técnica Motor Sumergible • Technical Information Sumersible

Bomba Pump	Potencia Power		Tipo Motor Motor Type	U _N	Información Motor • Motor information											
					n	I _N	I _A	η			cos φ			Ax.	P	L
	min ⁻¹	(A)			50	75	100	50	75	100	kN	(kg)	(mm)			
6SF-60/02R	4	5,5	EMC/6 5,5	400 V	2855	9,9	38	0,68	0,72	0,72	0,59	0,67	0,81	20	44,0	649
6SF-60/03R	5,5	7,5	EMC/6 7,5		2857	13,3	51	0,71	0,74	0,76	0,59	0,67	0,81		47,0	678
6SF-60/04R	7,5	10	EMC/6 10		2860	16,7	64,5	0,79	0,80	0,80	0,59	0,67	0,81		53,0	758
6SF-60/05R	9,3	12,5	EMC/6 12,5		2865	20,5	79,2	0,80	0,81	0,81	0,59	0,67	0,81		57,0	800
6SF-60/06R	11	15	EMC/6 15		2855	23,6	91,1	0,82	0,83	0,83	0,63	0,71	0,81		61,0	851
6SF-60/07R	13	17,5	EMC/6 17,5		2875	27,9	107,0	0,81	0,82	0,82	0,61	0,69	0,82		66,0	911
6SF-60/08R	15	20	EMC/6 20		2880	32,2	120,0	0,80	0,81	0,81	0,61	0,69	0,83		72,0	973
6SF-60/09..10R	18,5	25	EMC/6 25		2868	40,2	155	0,81	0,82	0,82	0,57	0,66	0,81		80,0	1006
6SF-60/11	22	30	EMC/6 30		2875	46,7	180	0,82	0,83	0,83	0,59	0,67	0,82		86,0	1106
6SF-60/12..13	26	35	EMC/6 35		2885	54,9	212	0,83	0,84	0,84	0,61	0,69	0,83		90,0	1217
6SF-60/14..15	30	40	EMC/6 40		2895	62,1	240	0,83	0,84	0,84	0,61	0,69	0,83	27	104,0	1247
6SF-60/16..19	37	50	EMC/6 50		2905	78,5	303	0,81	0,82	0,84	0,61	0,69	0,83	111,0	1347	
6SF-60/20..22	45	60	EMC/7 60		2890	88,0	446	0,84	0,86	0,86	0,75	0,83	0,86	45	142,0	1139

Más información en fichas técnicas motores sumergibles EMC • More information in technicals specifications of sumersible motors EMC
Cuerpo y Rodete • Body and Impeller
Eje Bomba y Acople • Pump shaft and Coupling
Rejilla y Válvula • Strainer and Valve cap
Diám. Impulsión • Outlet con. diam.
Max. Contenido Arena • Max. Sand Content
Fundición de Hierro GG-25 • Cast Iron GG-25
Acero Inoxidable • Stainless Steel
Acero Inoxidable • Stainless Steel
3" (rosca interior) • 3" (inside threaded)
50 gr/m³ • 50 gr/m³

Debido a continuas mejoras en los diseños, EMC BOMBAS se reserva el derecho de realizar modificaciones sin previo aviso.
 Due to continuous improvement in design EMC BOMBAS reserves the right to amend specifications or data without prior notice.

50Hz

Bombas Fundición de Hierro - Rodete en Hierro

Cast Iron Pumps - Impeller in Iron



6SF 60

Características 50Hz • Performance 50Hz

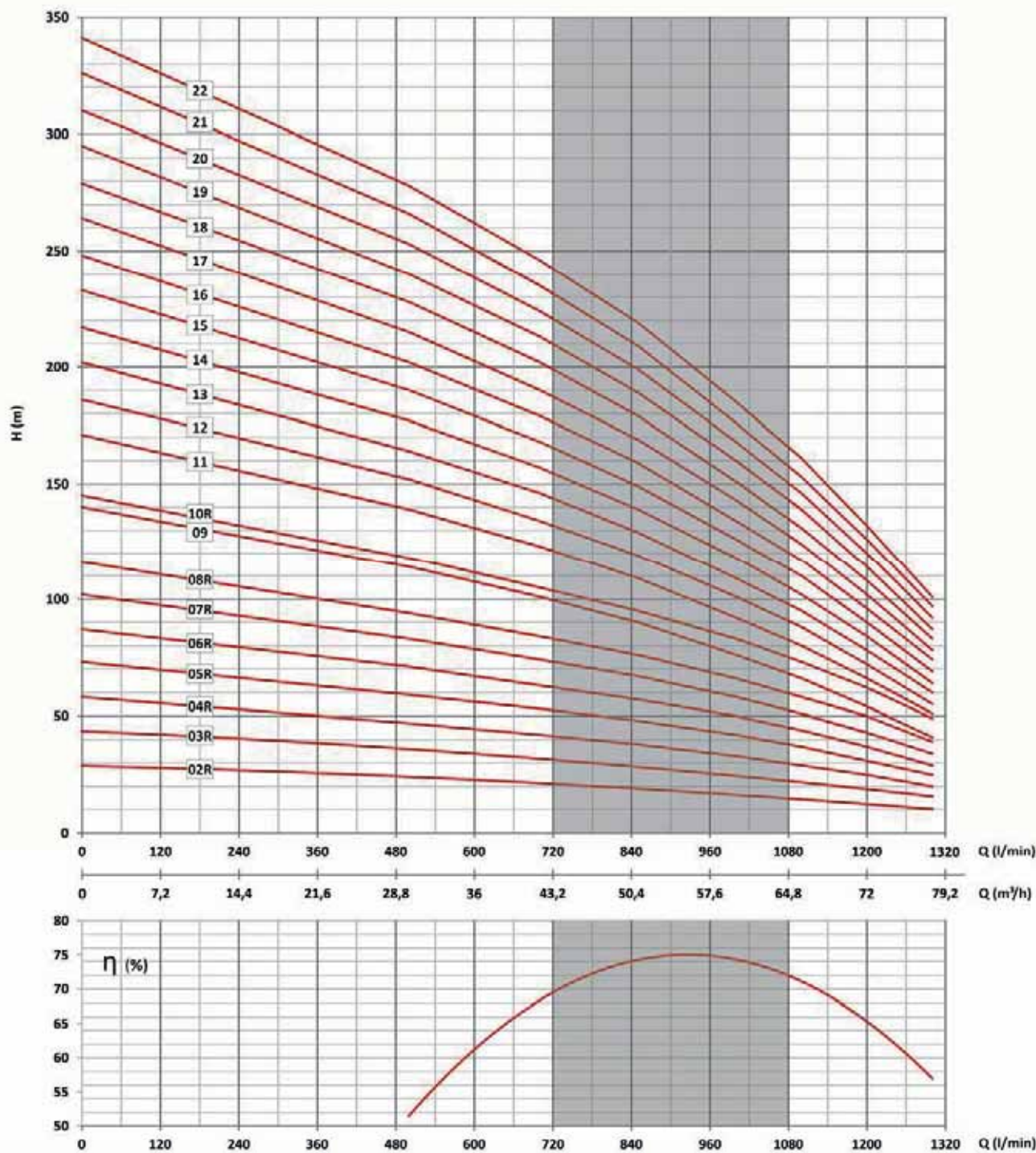

Dimensiones y pesos en páginas posteriores • Dimensions and weights in subsequent pages

Debido a continuas mejoras en los diseños, EMC BOMBAS se reserva el derecho de realizar modificaciones sin previo aviso.
Due to continuous improvement in design EMC BOMBAS reserves the right to amend specifications or data without prior notice.

Las condiciones de trabajo han sido tomadas en las siguientes condiciones: agua 15°C, presión atmosférica de 1 bar y densidad específica 1gr/cm³ según ISO 9906 Annex A.
The hydraulic working characteristics have been taken with water at 15°C, at the atmospheric pressure of 1 bar and specific gravity is 1gr/cm³, ISO 9906 Annex A.



Bombas Fundición de Hierro - Rodete en Hierro

Cast Iron Pumps - Impeller in Iron

50Hz

6SF 65

Características 50Hz • Performance 50Hz

Bomba Pump	Motor		Q	Caudal • Capacity											
			l/s	0	10,0	11,3	12,5	14,3	16,0	17,0	18,0	19,0	20,0	23,0	25,0
	m ³ /h	0	36,0	40,5	45,0	51,3	57,6	61,2	64,8	68,4	72,0	82,8	90,0		
	l/min	0	600	675	750	855	960	1020	1080	1140	1200	1380	1500		
6SF-65/02	4	5,5	Altura • Head H (m)	30	24	23	22	21	19	18	17	16	15	11	8
6SF-65/03	7,5	10		45	36	35	33	31	29	28	26	24	22	16	12
6SF-65/04	9,3	12,5		60	48	46	44	41	38	36	34	32	30	22	16
6SF-65/05	11	15		75	60	58	56	52	48	46	43	40	37	27	20
6SF-65/06	13	17,5		90	72	70	67	62	57	55	52	48	44	33	24
6SF-65/07	15	20		105	84	81	78	73	67	64	60	56	52	38	28
6SF-65/08	18,5	25		120	96	93	89	83	76	73	69	64	59	44	32
6SF-65/09	22	30		135	108	104	100	93	86	82	77	72	67	49	36
6SF-65/10	26	35		150	120	116	111	104	96	91	86	80	74	55	40
6SF-65/11	26	35		165	132	127	122	114	105	100	95	88	81	60	44
6SF-65/12	30	40		180	144	139	133	124	115	109	103	96	89	65	48
6SF-65/13	30	40		195	156	150	144	134	124	119	113	105	96	71	52
6SF-65/14	37	50		210	168	162	155	145	134	127	120	112	104	76	56
6SF-65/15	37	50		225	180	174	167	155	143	136	129	120	111	82	60
6SF-65/16	37	50		240	192	185	178	166	153	146	138	128	118	87	64
6SF-65/17	37	50		255	204	197	189	176	162	154	146	136	126	93	68
6SF-65/18	45	60		270	216	208	200	186	172	164	155	144	133	98	72
6SF-65/19	45	60		285	228	220	211	196	181	172	163	152	141	104	76
6SF-65/20	45	60		300	240	231	222	207	191	182	172	160	148	109	80
6SF-65/21	45	60		315	252	243	233	217	201	191	181	168	155	114	84

Información Técnica Motor Sumergible • Technical Information Sumersible

Bomba Pump	Potencia Power		Tipo Motor Motor Type	U _N	Información Motor • Motor information											
					n	I _N	I _A	η			cos φ			Ax.	P	L
	min ⁻¹	(A)	50		75	100	50	75	100	kN	(kg)	(mm)				
6SF-65/02	4	5,5	EMC/6 5,5	400 V	2855	9,9	38	0,68	0,72	0,72	0,59	0,67	0,81	20	44,0	649
6SF-65/03	7,5	10	EMC/6 10		2860	16,7	65	0,79	0,80	0,80	0,59	0,67	0,81		53,0	758
6SF-65/04	9,3	12,5	EMC/6 12,5		2865	20,5	79,2	0,80	0,81	0,81	0,59	0,67	0,81		57,0	800
6SF-65/05	11	15	EMC/6 15		2855	23,6	91,1	0,82	0,83	0,83	0,63	0,71	0,81		61,0	851
6SF-65/06	13	17,5	EMC/6 17,5		2875	27,9	107,0	0,81	0,82	0,82	0,61	0,69	0,82		66,0	911
6SF-65/07	15	20	EMC/6 20		2880	32,2	120,0	0,80	0,81	0,81	0,61	0,69	0,83		72,0	973
6SF-65/08	18,5	25	EMC/6 25		2868	40,2	155,0	0,81	0,82	0,82	0,57	0,66	0,81		80,0	1006
6SF-65/09	22	30	EMC/6 30		2875	46,7	180	0,82	0,83	0,83	0,59	0,67	0,82		86,0	1106
6SF-65/10..11	26	35	EMC/6 35		2885	54,9	212	0,83	0,84	0,84	0,61	0,69	0,83		90,0	1217
6SF-65/12..13	30	40	EMC/6 40		2895	62,1	240	0,83	0,84	0,84	0,61	0,69	0,83		27	104,0
6SF-65/14..17	37	50	EMC/6 50		2905	78,5	303	0,81	0,82	0,84	0,61	0,69	0,83	111,0		1347
6SF-65/18..21	45	60	EMC/7 60		2890	88,0	446	0,84	0,86	0,86	0,75	0,83	0,86	45		142,0

Más información en fichas técnicas motores sumergibles EMC • More information in technicals specifications of sumersible motors EMC

Cuerpo y Rodete • Body and Impeller

Eje Bomba y Acople • Pump shaft and Coupling

Rejilla y Válvula • Strainer and Valve cap

Diám. Impulsión • Outlet con. diam.

Max. Contenido Arena • Max. Sand Content

Fundición de Hierro GG-25 • Cast Iron GG-25

Acero Inoxidable • Stainless Steel

Acero Inoxidable • Stainless Steel

4" (rosca interior) • 4" (inside threaded)

50 gr/m³ • 50 gr/m³

Debido a continuas mejoras en los diseños, EMC BOMBAS se reserva el derecho de realizar modificaciones sin previo aviso.
Due to continuous improvement in design EMC BOMBAS reserves the right to amend specifications or data without prior notice.

50Hz

Bombas Fundición de Hierro - Rodete en Hierro
Cast Iron Pumps - Impeller in Iron

6SF 65

Características 50Hz • Performance 50Hz

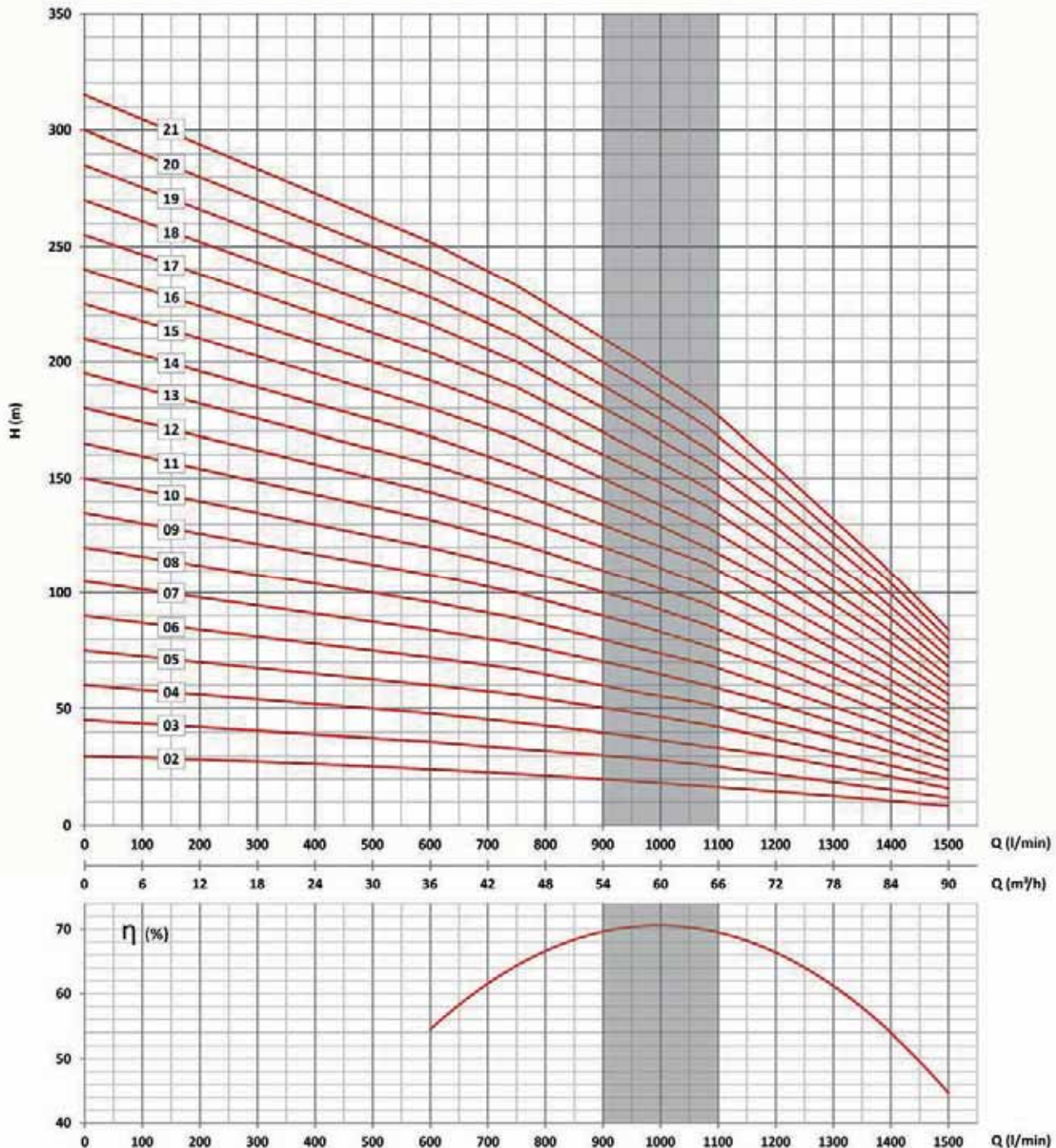

Dimensiones y pesos en páginas posteriores • Dimensions and weights in subsequent pages

Las condiciones de trabajo han sido tomadas en las siguientes condiciones: agua 15°C, presión atmosférica de 1 bar y densidad específica 1gr/cm³ según ISO 9906 Annex A.
 The hydraulic working characteristics have been taken with water at 15°C, at the atmospheric pressure of 1 bar and specific gravity is 1gr/cm³, ISO 9906 Annex A.

6SF 50

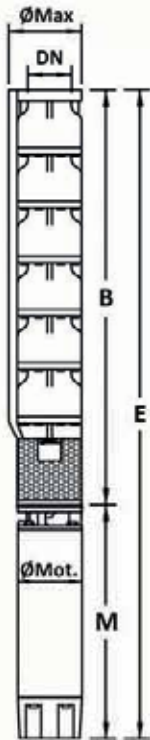

Dimensiones y Pesos
Dimensions and Weights

Dimensiones y peso de la bomba • Pump weight and dimensions							
Tipo Type	E	B	M	ØMax	ØMot.	DN	Peso Bomba Pump Weight
6SF-50/02	1256	607	649	153	144	3"	27
6SF-50/03	1402	724	678				33
6SF-50/04	1599	841	758				39
6SF-50/05	1758	958	800				45
6SF-50/06	1926	1075	851				51
6SF-50/07	2103	1192	911				57
6SF-50/08	2282	1309	973				63
6SF-50/09	2432	1426	1006				69
6SF-50/10	2549	1543	1006				75
6SF-50/11	2766	1660	1106				81
6SF-50/12	2994	1777	1217				87
6SF-50/13	3111	1894	1217				93
6SF-50/14	3258	2011	1247				99
6SF-50/15	3375	2128	1247				105
6SF-50/16	3492	2245	1247				111
6SF-50/17	3709	2362	1347				117
6SF-50/18	3826	2479	1347				122
6SF-50/19	3943	2596	1347				128
6SF-50/20	4060	2713	1347				134
6SF-50/21	4177	2830	1347		140		
6SF-50/22	4086	2947	1139		146		
6SF-50/23	4189	3050	1139		152		
6SF-50/24	4306	3167	1139		158		
6SF-50/25	4423	3284	1139		164		

6SF 60

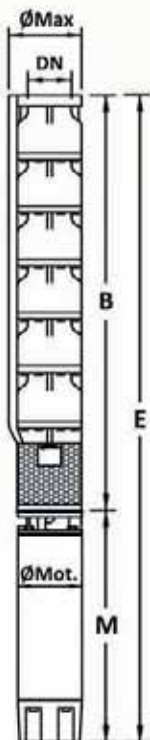

Dimensiones y Pesos
Dimensions and Weights

Dimensiones y peso de la bomba • Pump weight and dimensions							
Tipo Type	E	B	M	ØMax	ØMot.	DN	Peso Bomba Pump Weight
6SF-60/02R	1256	607	649	153	144	3"	27
6SF-60/03R	1402	724	678				33
6SF-60/04R	1599	841	758				39
6SF-60/05R	1758	958	800				45
6SF-60/06R	1926	1075	851				51
6SF-60/07R	2103	1192	911				57
6SF-60/08R	2282	1309	973				63
6SF-60/09	2432	1426	1006				69
6SF-60/10R	2549	1543	1006				75
6SF-60/11	2766	1660	1106				81
6SF-60/12	2994	1777	1217				87
6SF-60/13	3111	1894	1217				93
6SF-60/14	3258	2011	1247				99
6SF-60/15	3375	2128	1247				105
6SF-60/16	3592	2245	1347				111
6SF-60/17	3709	2362	1347				117
6SF-60/18	3826	2479	1347				122
6SF-60/19	3943	2596	1347				128
6SF-60/20	3852	2713	1139				134
6SF-60/21	3969	2830	1139		140		
6SF-60/22	4086	2947	1139		146		

Debido a continuas mejoras en los diseños, EMC BOMBAS se reserva el derecho de realizar modificaciones sin previo aviso.
Due to continuous improvement in design EMC BOMBAS reserves the right to amend specifications or data without prior notice.

50Hz

Bombas Fundición de Hierro - Rodete en Hierro

Cast Iron Pumps - Impeller in Iron

6SF 65

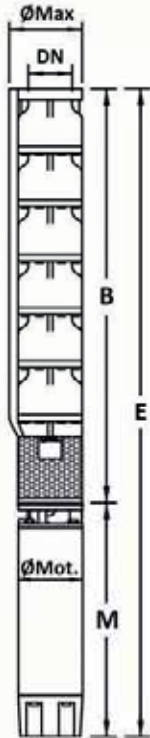

Dimensiones y Pesos
Dimensions and Weights

Dimensiones y peso de la bomba • Pump weight and dimensions							
Tipo Type	E	B	M	ØMax	ØMot.	DN	Peso Bomba Pump Weight
6SF-65/02	1256	607	649	153	144	4"	27
6SF-65/03	1482	724	758				33
6SF-65/04	1641	841	800				39
6SF-65/05	1809	958	851				45
6SF-65/06	1986	1075	911				51
6SF-65/07	2165	1192	973				57
6SF-65/08	2315	1309	1006				63
6SF-65/09	2532	1426	1106				69
6SF-65/10	2760	1543	1217				75
6SF-65/11	2877	1660	1217				81
6SF-65/12	3024	1777	1247				87
6SF-65/13	3141	1894	1247				93
6SF-65/14	3358	2011	1347				99
6SF-65/15	3475	2128	1347				105
6SF-65/16	3592	2245	1347				111
6SF-65/17	3709	2362	1347				117
6SF-65/18	3618	2479	1139				122
6SF-65/19	3735	2596	1139				128
6SF-65/20	3852	2713	1139				134
6SF-65/21	3969	2830	1139		140		

Las condiciones de trabajo han sido tomadas en las siguientes condiciones: agua 15°C, presión atmosférica de 1 bar y densidad específica 1gr/cm³ según ISO 9906 Annex A.
The hydraulic working characteristics have been taken with water at: 15°C, at the atmospheric pressure of 1 bar and specific gravity is 1gr/cm³, ISO 9906 Annex A.